

P1

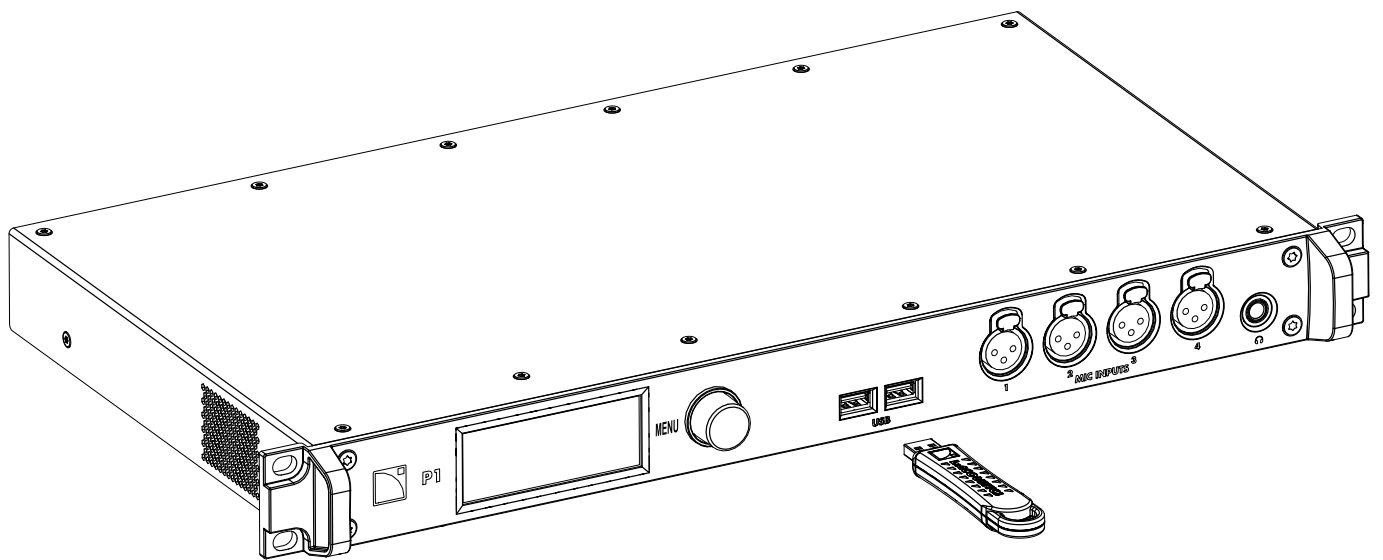

owner's manual (EN)



Document reference: P1 owner's manual (EN) version 6.2

Distribution date: August 31, 2023

© 2023 L-Acoustics. All rights reserved.

No part of this publication may be reproduced or transmitted in any form or by any means without the express written consent of the publisher.

Contents













Safety.....	6
Important safety instructions.....	6
Introduction.....	8
How to use this manual.....	8
P1 AVB processor and measurement platform.....	9
Revision history.....	10
System components.....	11
Technical description.....	12
Main features.....	12
Internal components.....	12
Front and rear panels.....	12
Signal processing.....	13
Signal inputs.....	13
Measurement and tuning.....	14
DSP architecture.....	14
Signal outputs.....	15
Power supply.....	15
Monitoring and control.....	15
User interface.....	15
L-NET remote control network.....	15
Inspection and preventive maintenance.....	16
How to do preventive maintenance.....	16
CHK - External structure.....	16
CHK - External cleanness.....	16
CHK - Network functionalities and firmware.....	17
Installation.....	18
Mounting.....	18
Ventilation.....	18
General Purpose I/O (GPIO).....	19
Audio and network cabling.....	20
Connection panels.....	20
Cabling example.....	22
Connecting to AC mains.....	23
Electrical specifications.....	23
Power cord.....	23

Plugging to AC mains.....	23
Power consumption.....	23
Powering on/off.....	24
Operation.....	24
Parameters accessible only from LA Network Manager.....	24
Using the interface.....	25
Unlocking the display.....	26
Using the main screen.....	26
Configuration information.....	26
DSP indicators.....	27
IP address.....	27
Level meters and mute.....	28
Time-alignment.....	29
Automatic input fallback.....	30
Using the input/output pages.....	33
Stacked views.....	35
Mute.....	35
Gain.....	36
Polarity.....	37
Signal status (AES and AVB).....	37
Mapping (AVB).....	40
Sampling frequency (AES).....	42
Mic/Line settings.....	43
Media Player (MPL).....	44
Generator.....	46
DSP (BUS and CUE).....	47
Source selection.....	52
Using the menu.....	53
Configurations.....	54
Media Clock.....	60
Monitoring & Info.....	62
Options.....	65
IP Settings.....	70
Identifying P1.....	72
Corrective maintenance.....	73
Introduction.....	73
Presentation.....	73
Equipment and tools.....	73
Troubleshooting and diagnosis.....	74
Power issues.....	74

Interface issues.....	74
Network issues.....	75
Error messages.....	75
Sound issues.....	76
Exploded view.....	78
Disassembly and Reassembly procedures.....	79
D/R - Encoder wheel knob.....	79
Specifications.....	80
General.....	80
Interface and connectors.....	80
Inputs and outputs.....	81
Signal processing.....	84
P1 Sensor.....	84
Remote control.....	84
Physical data.....	85
Appendix A - Glossary.....	86
Appendix B - List of AVB reservation (RSV) errors.....	86
Appendix C - List of AVB connection (CON) errors.....	88
Appendix D - Licenses and copyrights.....	88
Appendix E - Approvals.....	89

Safety

Important safety instructions

- 
Inspect the system before any deployment.
 Perform safety related checks and inspections before any deployment.
- 
Perform preventive maintenance at least once a year.
 Refer to the preventive maintenance section for a list of actions and their periodicity.
 Insufficient upkeep of the product can void the warranty.
- 
Verify the electrical conformity and compatibility of the mains supply.
 Only connect the product to an AC power outlet rated 100-240 V, 50-60 Hz.
 The product draws 27 W (typical).
WARNING: The product is of Class 1 construction and shall be connected to a mains socket outlet with a Protective Earth connection.
- 
When the product is used in a three-phase circuit, verify the electrical conformity and compatibility of the three-phase circuit.
 Verify that the three phases work, and balance the loads between the three phases.
 Verify that the neutral and earth work.
 Never try to emulate a 230 V circuit connecting an apparatus to two live wires of a 120 V three-phase circuit.
 Never try to emulate a 200 V circuit connecting an apparatus to two live wires of a 100 V three-phase circuit.
- 
Electrical generator
 You must power on the generator before powering on the product.
 Verify that the product is turned off before powering on the generator.
- 
 To reduce the risk of fire or electric shock, this apparatus should not be exposed to rain or moisture and objects filled with liquids, such as vases, should not be placed on this apparatus.
- 
Never incorporate equipment or accessories not approved by L-Acoustics.
Read all the related PRODUCT INFORMATION documents shipped with the products before exploiting the system.
- 
Intended use
 This system is intended for use by trained personnel for professional applications.
- 
As part of a continuous evolution of techniques and standards, L-Acoustics reserves the right to change the specifications of its products and the content of its documents without prior notice.
 Check www.l-acoustics.com on a regular basis to download the latest document and software updates.
- 
Do not use the product outside its operating temperature range.
 The product operates at a room temperature between 0 °C / 32 °F and 50 °C / 122 °F.
 Do not expose the product to direct sun.
- 
Do not expose the product to extreme conditions.
 Do not expose the product to moisture (rain, mist, sea spray, steam, humidity, condensation...) or excessive heat (direct sun, radiator...) for a long period of time.
 For more information, refer to the **Products weather protection** document, available on the website.
- 
Use the product in a conformed electro-magnetic environment.
 The product can be used in the following environment: residential (class B).
Avoid radio interference.
 This product has been tested and complies with the regulations of the EMC directive (Electro Magnetic Compatibility). These regulations are designed to provide reasonable protection against harmful interference from electrical equipment, but it cannot be guaranteed that interference will never occur.

- ! Product disconnection**
To completely disconnect this product from the mains, disconnect the power supply cord plug from the mains socket outlet.
- ! Power supply cord and socket accessibility**
The main plug of the power supply cord shall remain easily accessible.
The mains socket outlet shall be easily accessible.
- ! Read the maintenance section of this document before servicing the product.**
- ! Contact L-Acoustics for advanced maintenance.**
Any unauthorized maintenance operation will void the product warranty.
- ! Shipping**
Use the original packaging for shipping the product, unless it is mounted in a rack with the front fixed to the rack, as described in this manual.

Symbols on the product



Explanation of graphical symbols



The lightning flash with arrowhead symbol within an equilateral triangle is intended to alert the user to the presence of uninsulated "dangerous voltage" within the product's enclosure that may be of sufficient magnitude to constitute a risk of electric shock to persons.



The exclamation point within an equilateral triangle is intended to alert the user to the presence of important operating and maintenance instructions in the literature accompanying the product.



Do not open unless authorized. This symbol indicates the presence of electrical shock hazards. It also indicates that no maintenance performed by the end user requires access to internal components.



This marking indicates that this product should not be disposed of with other household waste throughout the EU. To prevent possible harm to the environment or human health from uncontrolled waste disposal, recycle it responsibly to promote the sustainable reuse of material resources. To return your used device, please use the return and collection systems or contact the retailer where the product was purchased. They can take this product for environmentally safe recycling.

Introduction

How to use this manual

The P1 owner's manual is intended for all actors involved in the system design, implementation, preventive and corrective maintenance of the P1 product. It must be used as follows:

1. Read the technical description for an overview of all product elements, their features, and their compatibilities.
 - [Technical description](#) (p.12)
2. Before installing the product, perform mandatory inspections and functional checks.
 - [Inspection and preventive maintenance](#) (p.16)
3. To deploy the product, follow the step-by-step installation instructions and refer to the cabling schemes.
 - [Installation](#) (p.18)
4. To configure the settings and parameters of the product, follow the step-by-step operation instructions.
 - [Operation](#) (p.24)



The [Corrective maintenance](#) (p.73) section contains the operations authorized for the end user. Performing another operation exposes to hazardous situations. For advanced maintenance, contact your L-Acoustics representative.

As part of a continuous evolution of techniques and standards, L-Acoustics reserves the right to change the specifications of its products and the content of its documents without prior notice.

Check www.l-acoustics.com on a regular basis to download the latest document and software updates.

Contact information

For information on advanced corrective maintenance:

- contact your Certified Provider or your L-Acoustics representative
- for Certified Providers, contact the L-Acoustics customer service: customer.service@l-acoustics.com (EMEA/APAC), laus.service@l-acoustics.com (Americas).

Symbols

The following symbols are used in this document:



This symbol indicates a potential risk of harm to an individual or damage to the product.

It can also notify the user about instructions that must be strictly followed to ensure safe installation or operation of the product.



This symbol indicates a potential risk of electrical injury.

It can also notify the user about instructions that must be strictly followed to ensure safe installation or operation of the product.



This symbol notifies the user about instructions that must be strictly followed to ensure proper installation or operation of the product.



This symbol notifies the user about complementary information or optional instructions.

P1 AVB processor and measurement platform



L-Acoustics P1 is an AVB processor and measurement platform. Remote controlled from LA Network Manager Windows/ macOS software together with L-Acoustics amplified controllers, its 20 inputs / 16 outputs dual core DSP platform provides a comprehensive solution for mixing desk selection, signal processing and distribution over AVB networks, AES/ EBU or analog lines.

P1 includes four microphone inputs and an advanced library of acoustic measurement functions for efficient system tuning. The workflow is twofold: the impulse responses of all parts of the system are acquired from multiple audience locations; then, optimal system tuning is directly determined from LA Network Manager with automatic delay finder and EQ modelization offline algorithms. Thanks to a powerful database architecture and online integration with amplified controllers, the System Engineer can easily select and apply the settings that will achieve the desired result in accordance with the Soundvision design, the audience characteristics, and the artistic objectives.

Revision history

version number	publication date	modification
1.0	Jun. 2018	Initial version.
1.1	Jul. 2018	Fixed minor issues.
2.0 / 2.1	Oct. 2018	Fixed minor issues.
3.0	Feb. 2019	Updated preventive maintenance section.
4.0	Apr. 2019	Updated section on IP settings configuration.
4.1	Jun. 2019	Fixed minor issues.
4.2	Dec. 2019	Fixed minor issues.
4.3	Jan. 2020	Added information on improved DSP capabilities.
5.0	Apr. 2020	Added information on AVB streams and AVB redundancy.
5.1	May 2020	Added preventive maintenance warnings.
5.2	Jan. 2021	<ul style="list-style-type: none"> • Added fan noise specifications. • Improved description of General Purpose I/O. • Fixed avcontrol email address. • Added information on the selection of the AES outputs sampling frequency.
5.3	Mar. 2021	Added information on Media Clock mismatch.
5.4	Sep. 2021	Updated supported audio formats specifications for the Media Player.
6.0	Feb. 2022	Added new cables (DOE2, DOE45, and DOE100). Refer to System components (p.11).
6.1	Jun. 2023	<ul style="list-style-type: none"> • Changed screen color in Identifying P1 (p.72). • Updated instructions for setting a gateway IP address in Configuring the IP settings (p.71). • Added error message descriptions in Error messages (p.75).
6.2	Aug. 2023	Removed CCC certification.

System components

Processor

P1 AVB processor and measurement platform

Loudspeaker enclosures

! Refer to the user documentation of the loudspeaker systems for detailed instructions about the enclosures and their connection to the amplified controllers.

Powering and driving system

LA8 Amplified controller with DSP, preset library and networking capabilities

LA4X Amplified controller with DSP, preset library and networking capabilities

LA12X Amplified controller with DSP, preset library and networking capabilities

Cables

DOE cables Dual AVB Network cable CAT6A, etherCON (black = primary network, red = secondary network)

Come in different sizes: DOE2 (2 m / 6.6 ft), DOE45 (45 m / 147.6 ft), and DOE100 (100 m / 328.1 ft)

Software applications

LA Network Manager Software for remote control and monitoring of amplified controllers

i Refer to the **LA Network Manager** help.

System component illustrations

Cables

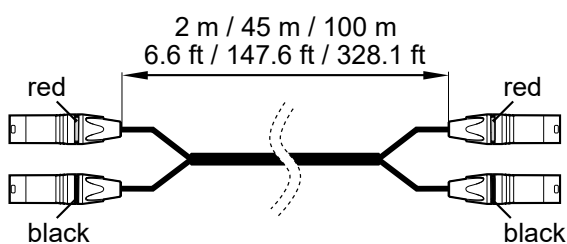

DOE cables

Software applications

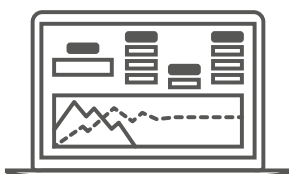

LA Network Manager

Technical description

Main features

Internal components

P1 has 20 inputs:

- four microphone inputs with switchable +48 V phantom power and high-pass filter.
- four analog line inputs with high-quality A/D conversion
- four AES/EBU inputs with high-quality Sample Rate Converter (SRC)
- one AVB listener capable of retrieving up to eight audio channels from two streams

Its dual DSP core allows to mix these inputs to eight independent DSP busses for EQ and dynamics signal processing, and/or route them directly to any of the 16 + 2 outputs:

- four analog line outputs with high-quality D/A conversion
- four AES/EBU outputs
- one AVB talker capable of sending up to eight audio channels in two streams
- one stereo headphone output

Power is provided by a universal Switched Mode Power Supply (SMPS). Control is possible from the front panel TFT color touchscreen display user interface, and remotely over 1 Gb/s Ethernet. One General Purpose I/O (GPIO), containing two GPI and two GPO, allows for control of preconfigured status or operations. Two USB 2.0 host connectors allow the connection of the P1 Sensor for temperature and humidity measurement or a USB storage device (max. 500 mA / 5 V).

Front and rear panels

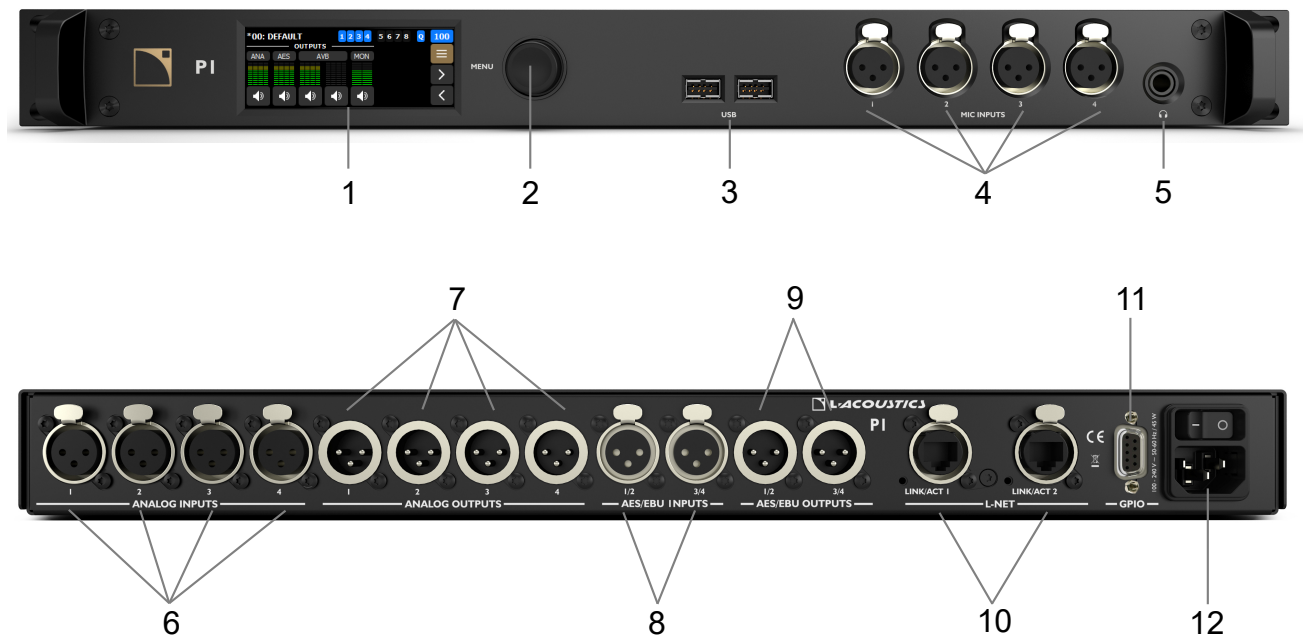

- | | |
|---|---|
| 1 TFT color touchscreen display (320 × 120 px) | 6 XLR analog input connectors |
| 2 encoding wheel with push button | 7 XLR analog output connectors |
| 3 USB 2.0 host connectors | 8 XLR AES/EBU input connectors |
| 4 XLR analog mic input connectors | 9 XLR AES/EBU output connectors |
| 5 1/4 inch stereo headphone jack | 10 EtherCON connectors (L-NET and AVB) |
| | 11 General Purpose I/O (GPIO) DB9 female connector |
| | 12 IEC C13 V-Lock compatible socket with on/off switch |

Signal processing

Signal inputs

P1 features 10 XLR connectors capable of receiving up to 12 input signals: four microphones, four analog lines, four AES/EBU signals (transported in pairs).

In addition, eight channels may be retrieved from two AVB streams at 48 kHz or 96 kHz, connected to the two 1 Gb/s Ethernet ports.

AVB

In normal mode, P1 can receive two independent AVB streams of eight channels each that can be combined into one AVB listener stream of eight channels via the input mapping menu. P1 operates as an AVB bridge and may therefore be used to create an AVB network.

In redundancy mode, P1 can receive two parallel AVB streams of up to eight channels each on two separate networks. The two Ethernet ports are independent and may therefore be used to create two separate networks (primary and secondary) for seamless redundancy.

Each connector uses a high speed data transfer protocol up to 1 Gb/s and supports the AAF PCM32 and IEC 61883-6 AM824 stream formats with stream frequencies of 48 kHz or 96 kHz.

AES/EBU

P1 can receive four AES/EBU digital audio signals (transported in pairs) using the two AES/EBU input connectors on the rear panel.

Each connector is an ESD protected female XLR3.

Each AES/EBU input port is equipped with a Sample Rate Converter (SRC) selected to support a wide range of input formats (16, 18, 20 or 24 bits / 44.1, 48, 88.2, 96, 176.4 or 192 kHz). It converts them to the 24 bits / 96 kHz internal format. The SRC is a high-quality hardware component (140 dB dynamic range, < -120 dBFS THD+N, strong input jitter attenuation) and provides constant propagation delay regardless of the input sampling frequency. There is no external synchronization mode. The processor clock runs either using its high-precision internal quartz at 96 kHz, or on the clock of the connected AVB input stream.

Analog line

P1 can receive four balanced analog line signals using the four analog input connectors on the rear panel. The maximum input signal level is +22 dBu.

Each connector is an ESD protected female XLR3.

To be processed by the DSP, the analog signal is converted into a digital signal. For this purpose, P1 is fitted with an A/D converter operating at 32-bit/96 kHz.

Microphone

P1 can receive four analog mic/line signals using the four MIC input connectors on the front panel. The maximum input signal level is +22 dBu (at 0 dB gain). Gain range is 0 dB to 60 dB.

Each connector is an ESD protected female XLR3.

Other

P1 features two USB 2.0 host connectors and a General Purpose I/O (GPIO) female DB9 connector connector.

The two USB 2.0 host connectors can be used to connect the P1 Sensor for temperature and humidity measurement, or a USB storage device.



If a connected device draws more than 500 mA / 5 V, both USB ports stop working.

Do not charge phones on P1.

If the USB ports stop working, disconnect the device and power cycle P1.

Measurement and tuning

P1 is the measurement platform for LA Network Manager 3.0, using the four MIC input connectors for multi-microphone measurement and the USB P1 Sensor for temperature and humidity acquisition.



Refer to the LA Network Manager Help for detailed instructions.

DSP architecture

The DSP engine is a 32-bit floating point DSP at 96 kHz sampling rate. It provides an enhanced dynamic range as it does not produce internal signal clipping like a fixed point DSP.

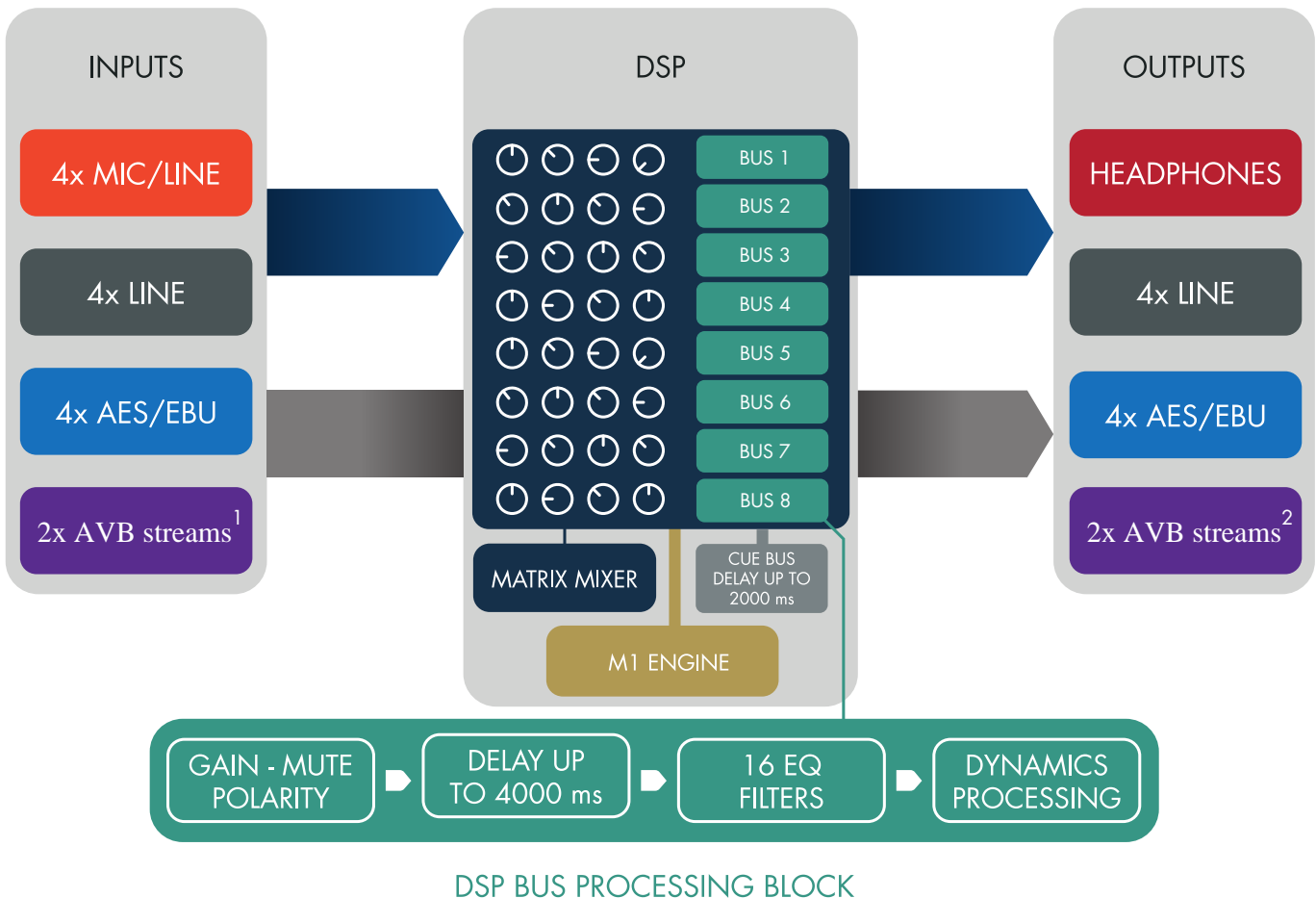

1. Two independent streams of up to 8 channels each in normal mode (6 ch. available when Media Player is enabled).
Two parallel streams of up to 8 channels each in redundancy mode.

2. Two independent streams of up to 8 channels each in normal mode (restrictions apply in measurement mode).
Two parallel streams of up to 8 channels each in redundancy mode.

Signal outputs

P1 features six XLR connectors capable of distributing up to eight output signals: four analog lines and four AES/EBU signals (transported in pairs).

In addition, eight channels may be transmitted using two AVB streams at 48 kHz or 96 kHz through the L-NET 1 Gb/s Ethernet ports.

Analog line outputs

P1 can distribute four analog line signals using the four analog output connectors on the rear panel.

Each connector is an ESD protected male XLR3.

AES/EBU outputs

P1 can distribute four AES/EBU digital audio signals (transported in pairs) using the two AES/EBU output connectors on the rear panel.

Each connector is an ESD protected male XLR3.

AVB outputs

In normal mode, P1 can distribute eight AVB output channels into two independent AVB streams of eight channels each. P1 operates as an AVB bridge and may therefore be used to create an AVB network.

In redundancy mode, P1 can distribute eight AVB output channels into two parallel AVB streams of eight channels each. The two Ethernet ports are independent and may therefore be used to create two separate networks (primary and secondary) for seamless redundancy.

Each connector uses a high speed data transfer protocol up to 1 Gb/s and supports the AAF PCM32 and IEC 61883-6 AM824 stream formats, with stream frequencies of 48 kHz or 96 kHz.

Other outputs

P1 features a 1/4 inch stereo headphone jack.

Some P1 feature a USB port marked DBG. This port is reserved for advanced maintenance operations by qualified L-Acoustics personnel.

Power supply

P1 relies on a universal Switched Mode Power Supply (SMPS) suitable for mains from 100 V AC - 240 V AC ($\pm 10\%$), 50 Hz - 60 Hz.

Monitoring and control

User interface

The front panel is fitted with a 320 × 120 px TFT color touchscreen display and an encoding wheel with push button.



Refer to section [Operation](#) (p.24) for detailed instructions.

L-NET remote control network

L-NET is an Ethernet-based network with a high speed data transfer protocol up to 1 Gb/s.

P1 is connected to the computer running LA Network Manager using either of its two etherCON connectors on the rear panel and industry standard CAT5e U/FTP cables (or higher category) fitted with RJ45 connectors.



Refer to the **LA Network Manager** Help for detailed instructions (in section **User guide > General**).

Inspection and preventive maintenance

How to do preventive maintenance

Inspect the product periodically as indicated, and after any corrective maintenance operation.

Structure and cleanness

Before and after each deployment (touring applications), or at least once a month (fixed installations):

- [CHK - External structure](#) (p.16)
- [CHK - External cleanness](#) (p.16)

Functionalities

At least once a year:

- [CHK - Network functionalities and firmware](#) (p.17)

CHK - External structure

The  indicates a visual inspection.

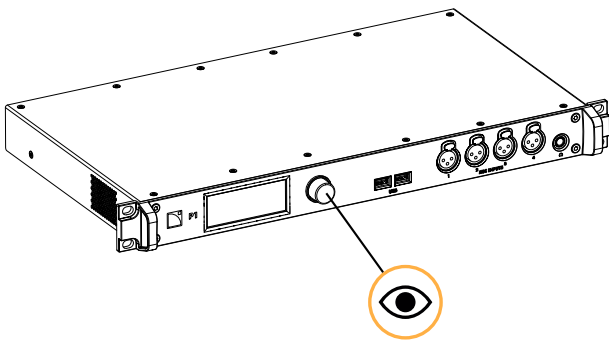

encoder wheel knob is present

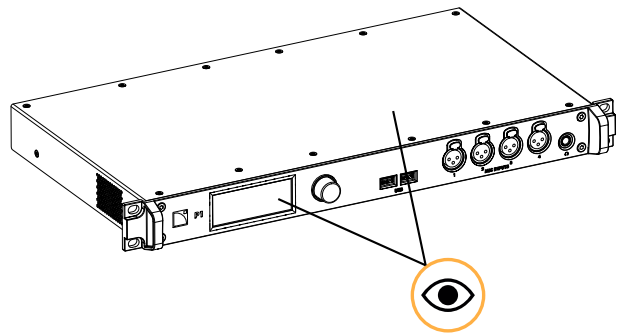

front panel touchscreen display and chassis are not damaged

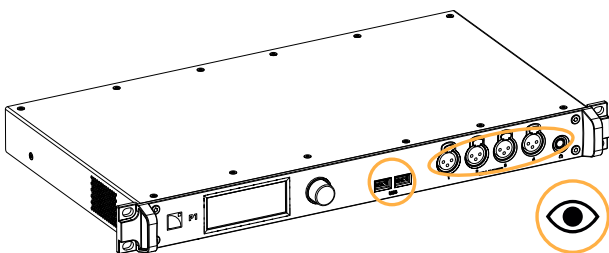

front and rear connectors are not damaged

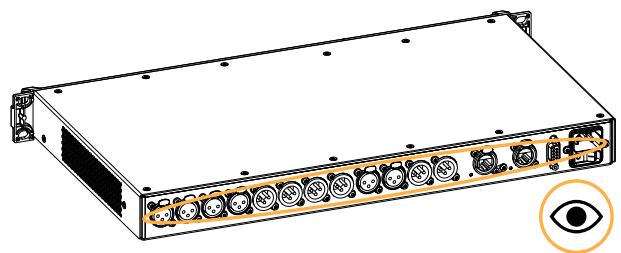

CHK - External cleanness

Use a dry cloth to remove any dust from the side grills.

CHK - Network functionalities and firmware

Equipment

- computer with LA Network Manager (version 2.6 minimum) and CAT5e U/FTP cable

Procedure

1. Connect the processor to an Ethernet port of a computer running LA Network Manager.
Use the CAT5e U/FTP cable.
2. Open LA Network Manager and set it on online mode.
3. Check that the processor is detected as an online Unit.
Refer to the LA Network Manager Help.
4. Check that all L-Acoustics processors in the system run the same version of the firmware.
The version of the firmware should match with the version of LA Network Manager in use. Refer to the **LA NWM and firmware compatibility issues** technical bulletin.
5. If convenient, update LA Network Manager and the firmware to the latest versions.
 If using a third-party control system such as Crestron or Extron, check that updating firmware does not break compatibility.

Installation

Mounting

P1 is one rack unit high (1U) and can be mounted in an EIA-standard 19" rack using the four points on the front panel. Use the fixing material provided by the rack manufacturer to mount the processor to the rack front rails.

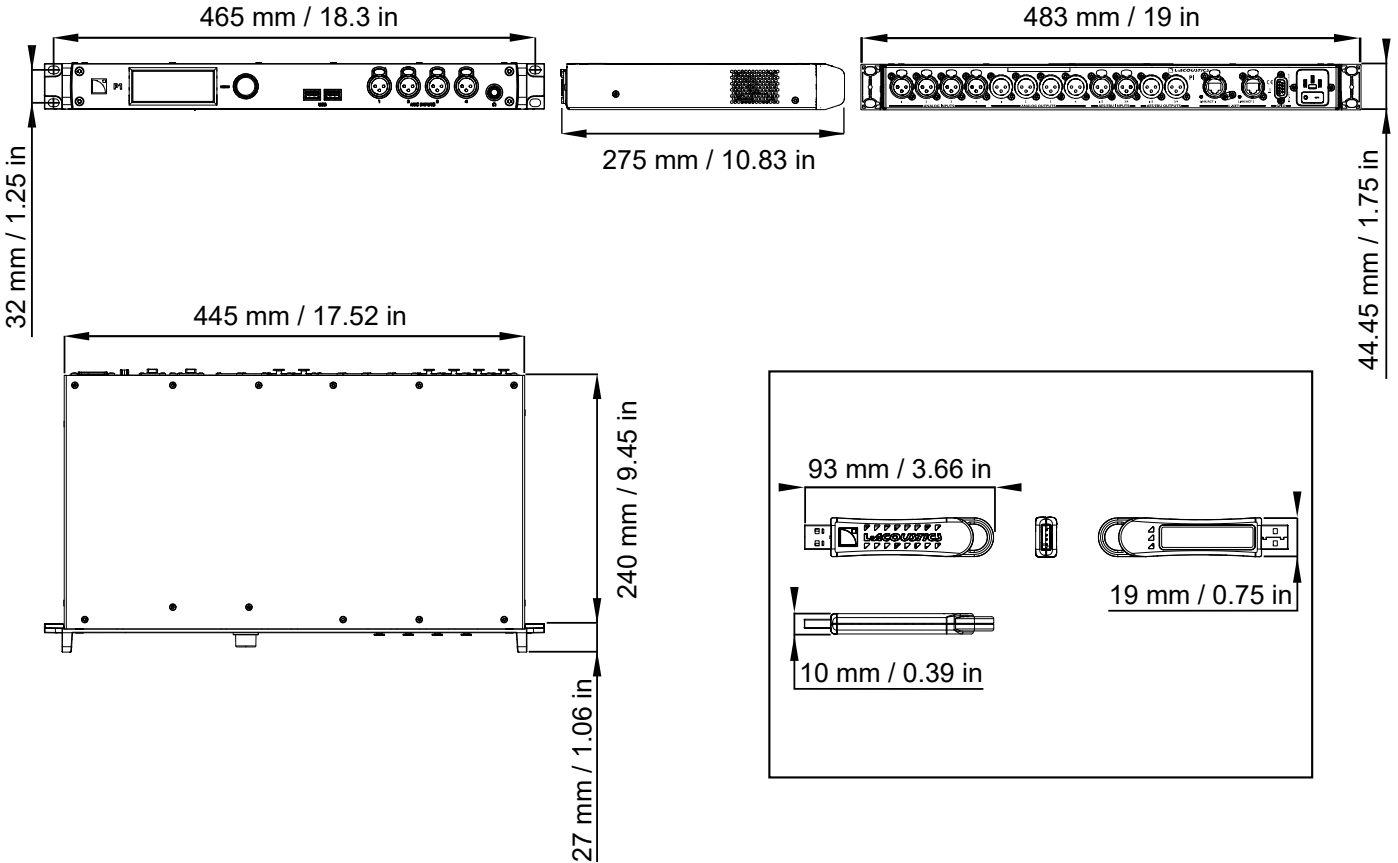

! P1 is not compatible with L-Case.

Ventilation

To maintain moderate operating temperatures, P1 is equipped with side grills and a fan with temperature-controlled speed (internal temperature probe).

The air flows from the right side to the left side (when looking at P1 from the front).

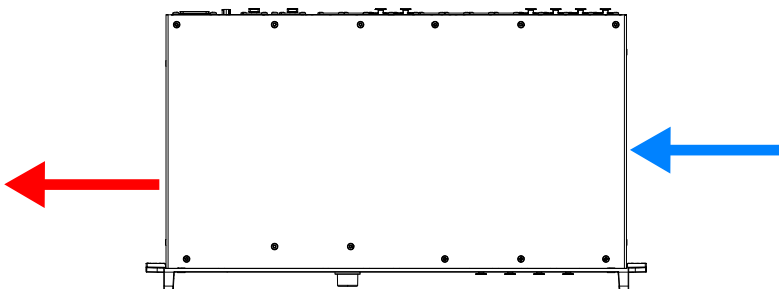

! Do not block the side ventilation grills. Install the processor with the side panels at a minimum distance of 5 cm from any external object or structure. When rack-mounted, make sure airflow is not reduced.

General Purpose I/O (GPIO)

P1 features a female DB9 connector on the rear panel.

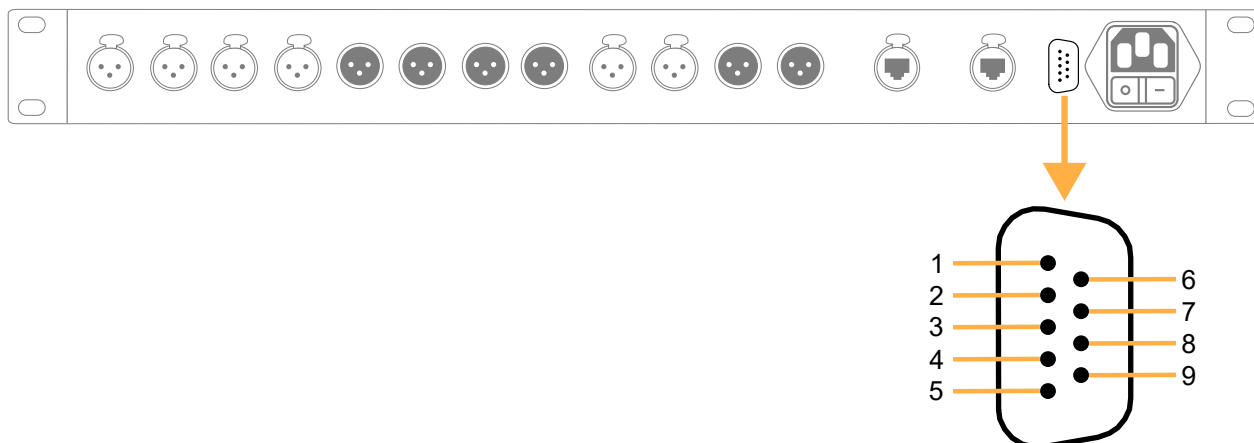

1	OUT1+	fully isolated output, relay contact
2	OUT1-	fully isolated output, relay contact
3	OUT2+	fully isolated output, relay contact
4	OUT2-	fully isolated output, relay contact
5	IN1+	fully isolated input
6	IN1-	fully isolated input
7	IN2	referenced to chassis ground
8	+5 V / 50 mA power	referenced to chassis ground
9	CHGND	chassis ground

The following messages can be displayed when an impossible action is triggered.

<code>GPI # error: Cannot load cfg Configuration loading disabled</code>	Displayed if the GPIO is programmed to load a configuration, but the configuration menu is disabled because LA Network Manager is connected.
<code>GPI # error: Cannot load cfg A Invalid configuration index</code>	Displayed if the GPIO is programmed to load a configuration, but the selected configuration memory space is empty.
<code>GPI # error: Cannot load cfg B Invalid cconfiguration index</code>	Displayed if the GPIO is programmed to load a configuration, but the selected configuration memory space is empty.
<code>GPI # error: Cannot load next cfg No next configuration found</code>	Displayed if the GPIO is programmed to load the next configuration, but the next configuration memory space is empty.
<code>GPI # error: Cannot load prev. cfg No previous configuration found</code>	Displayed if the GPIO is programmed to load the previous configuration, but the previous configuration memory space is empty.

i The preconfigured functions supported by P1 GPIO can be selected using LA Network Manager from version 3.2 when the GPIO Selector is enabled in the Options (refer to the Help).
Contact avcontrol@l-acoustics.com for more information.

Audio and network cabling

Connection panels

P1 features input, output and L-NET/AVB connectors on its front and rear panels for audio and network connection.

! Do not connect the P1 outputs to its own inputs.
Risk of damage to the product and the system.

input and L-NET connectors

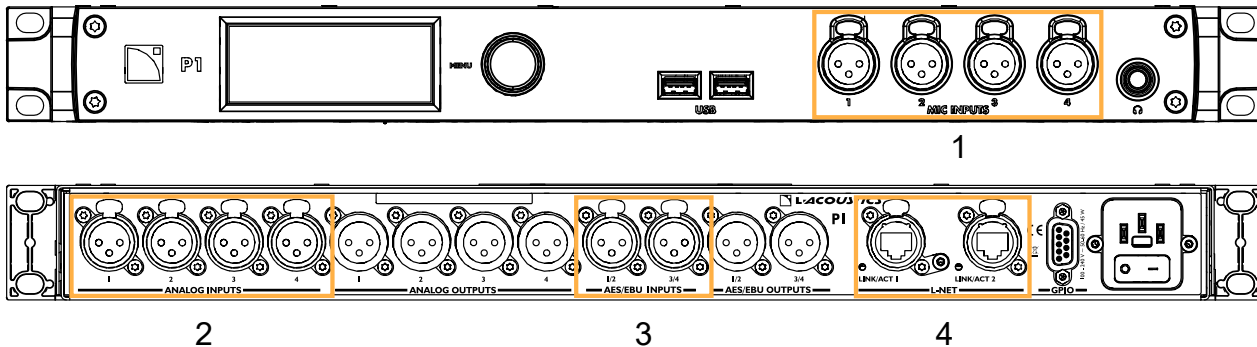

output connectors

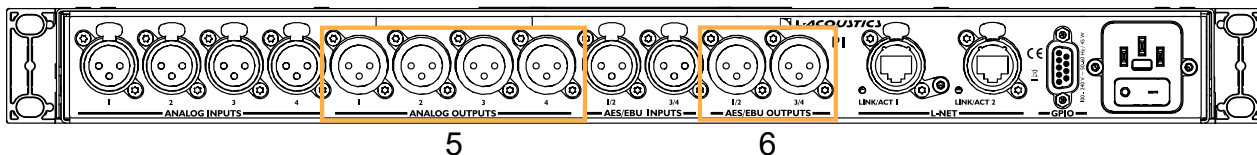

1. Analog mic inputs (front panel)
2. Analog line inputs
3. AES/EBU inputs
4. Ethernet connectors for L-NET and AVB networks
5. Analog line outputs
6. AES/EBU outputs

The XLR3 connectors are wired according to IEC 60268-12:

- pin 1: shield
- pin 2: + signal
- pin 3: - signal

Analog connectors

The MIC INPUTS 1 to 4 connectors (front panel) can receive four analog input signals. The ANALOG INPUTS 1 to 4 connectors (rear panels) can receive four analog input signals. The headroom is high enough to accept up to +22 dBu input levels (at 0 dB gain).

The ANALOG OUTPUTS 1 to 4 connectors (rear panel) can send four analog output signals. The maximum output level is +22 dBu (at 0 dB gain).

! Loss in the analog signal
Do not load P1 outputs with less than 600 Ω.

i Balanced cables
Symmetrical (balanced) shielded cables are highly recommended as balanced signals are less sensitive to AC hum and radio interference.
Unbalanced lines may add noise especially over long cable runs.

AES/EBU connectors

The AES/EBU INPUTS 1/2 and 3/4 connectors (rear panel) can receive four digital input signals.

The AES/EBU OUTPUTS 1/2 and 3/4 connectors (rear panel) can send four digital output signals.



Supported digital input format

Standards: AES/EBU (AES3) or electrical S/PDIF (IEC 60958 Type II)

Sampling frequency: 44.1 kHz, 48 kHz, 88.2 kHz, 96 kHz, 176.4 kHz, or 192 kHz

Word length: 16 bits, 18 bits, 20 bits, or 24 bits

Cables for AES/EBU digital audio

AES3 specifies that the nominal characteristic impedance of cables used for AES/EBU digital audio transmission shall be $110 \Omega \pm 20\%$, and closer tolerances allow for increased transmission reliability over long lengths or higher sampling rates.

Therefore, it is highly recommended to use high-quality AES/EBU rated cables only, although certain cables designed for balanced analog audio prove to be acceptable at 48 kHz sampling rate over very short distances.

It is recommended to use single lengths of cable between AES/EBU outputs and inputs. Using several shorter cables joined together reduces performance. If it is not possible to use single lengths, it is required to use the same model of cable between two AES/EBU interfaces.

In case of transmission losses, try to reduce the sampling frequency of the digital audio source. Moreover, as a general rule, avoid using sources rated beyond 96 kHz, as the maximum possible cable length is reduced, while the additional information is discarded by the SRC to 96 kHz.

P1 has been tested with up to 200 m / 656 ft of OT234H AES/EBU rated cables from KLOTZ communications GmbH (single cuts, digital source signal running at $F_s = 96$ kHz, tested for input and output).

Ethernet connectors

Use the two etherCON connectors for the remote control of P1 over the L-NET network using LA Network Manager. The etherCON connectors are AVB-capable.

In normal network mode, the two etherCON connectors are part of an internal AVB switch, and allow for daisy-chaining of additional devices.

In redundancy mode, the two etherCON connectors are independent: the LINK/ACT 1 connector is used for the primary network, and the LINK/ACT 2 connector is used for the secondary network.

Refer to the amplified controller owner's manuals and the **LA Network Manager** Help for more information on how to connect amplified controllers and P1 to the L-NET / AVB network in daisy-chain, star or hybrid topologies.

Cabling example

P1 can be used for:

- Time-aligned redundant AVB, AES/EBU, and analog signal distribution (to LA-RAK II AVB for example).
- AVB to AES/EBU or analog bridge (for non-AVB amplified controllers like LA8).
- Integration of other platforms (like the self-powered P series).
- Audio playback (with a USB drive and the P1 Media Player).
- System measurement and tuning: multi-microphone measurement with temperature and humidity acquisition (with LA Network Manager 3.0 and the P1 Sensor).

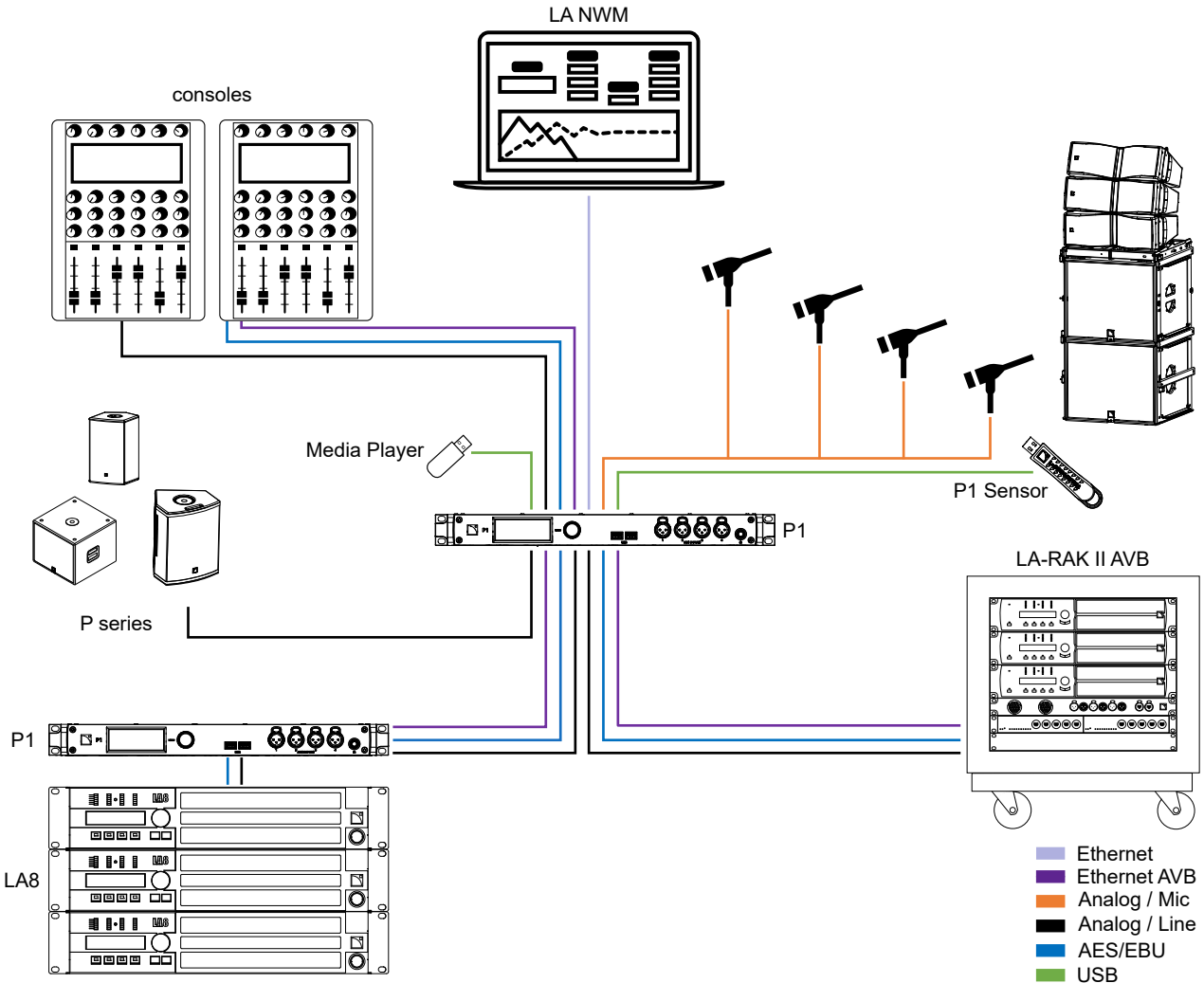

i System measurements from LA Network Manager 3.0

Generated sweeps disable AVB output 5 to 8, and all inputs except MIC.
Refer to the LA Network Manager Help for more information.

Connecting to AC mains

Electrical specifications

AC mains specifications

Verify the electrical conformity and compatibility of the mains supply.

Only connect the product to an AC power outlet rated 100-240 V, 50-60 Hz.

The product draws 27 W (typical).

WARNING: The product is of Class 1 construction and shall be connected to a mains socket outlet with a Protective Earth connection.

Three-phase circuit

When the product is used in a three-phase circuit, verify the electrical conformity and compatibility of the three-phase circuit.

Verify that the three phases work, and balance the loads between the three phases.

Verify that the neutral and earth work.

Never try to emulate a 230 V circuit connecting an apparatus to two live wires of a 120 V three-phase circuit.

Never try to emulate a 200 V circuit connecting an apparatus to two live wires of a 100 V three-phase circuit.

Power cord

The removable IEC cord is fitted with a female IEC C13 connector with V-Lock at one end and a country-specific plug at the other end.

type	plug	cable ratings	live	neutral	ground
CE	CEE 7/7, earthed	10 A / 250 V	brown	blue	green/yellow
CN	GB 2099, earthed				
INT	bare ends (local power plug to be fitted)				
JP	JIS C 8303, earthed	7 A / 125 V	black	white	green
US	NEMA 5-15, earthed	10 A / 125 V			

 Strictly apply the specific safety regulations of the country of use.

Do not defeat the ground connection of the supplied power cord using an adaptor or any other method.

Plugging to AC mains

Procedure

- Connect the power cord female IEC C13 connector to the processor male IEC C14 socket.

 **Check that the cable is properly locked.**

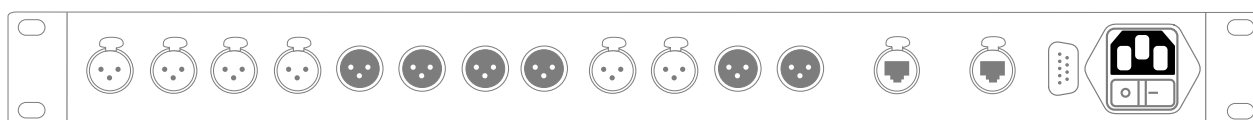

- Connect the power cord country-specific plug to the mains socket.

Power consumption

P1 power requirement is 27 W.

Powering on/off

The on/off switch is located on the rear panel.

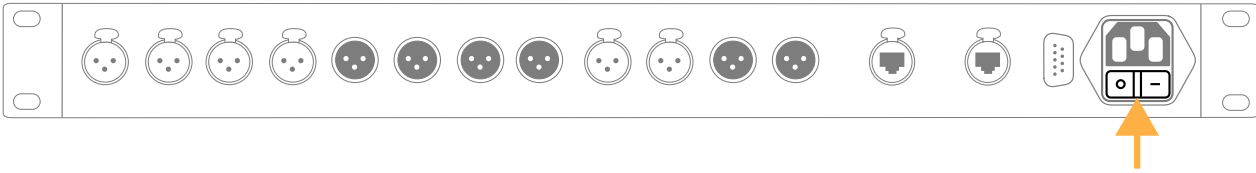

i Powering off does not disconnect from mains.

! If the product is exposed to condensation, power on, then wait 30 minutes before use.

Operation

Parameters accessible only from LA Network Manager

Most parameters are accessible both from the P1 front panel and from LA Network Manager.

The following can only be performed from LA Network Manager:

- Reboot.
- AVB stream selection - refer to [Signal status \(AES and AVB\)](#) (p.37) for the current stream status, and to [Mapping \(AVB\)](#) (p.40) to edit the mapping.
- Time-alignment - refer to [Time-alignment](#) (p.29) for the indicators.
- Fallback - refer to [Automatic input fallback](#) (p.30) for the indicators.
- Matrix mixer edition - refer to [Matrix mixer view \(DSP BUS\)](#) (p.47) for the read-only view.
- 8x8 matrix alignment delay - refer to [8x8 matrix alignment delay](#) (p.47) for the indicators.
- EQ station - refer to [Group Parameters \(DSP BUS\)](#) (p.50) for the read-only view.

Using the interface

P1 is equipped with an encoding wheel with push button and a color touchscreen display.

Navigating between pages:

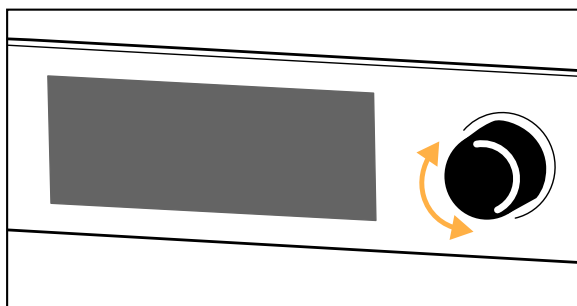
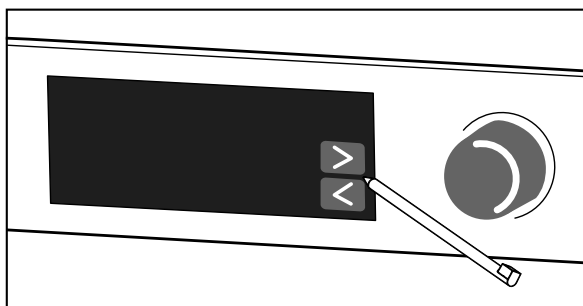

Changing selection or setting:

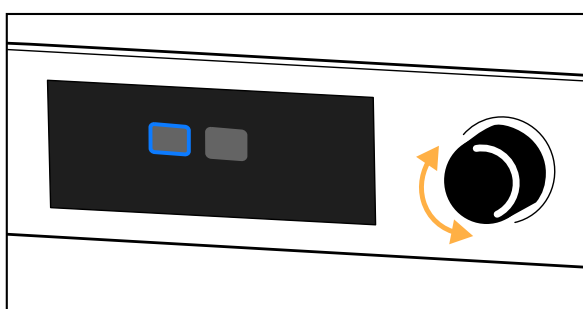

Validating selections:

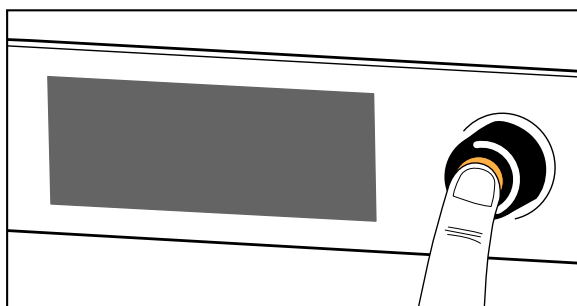
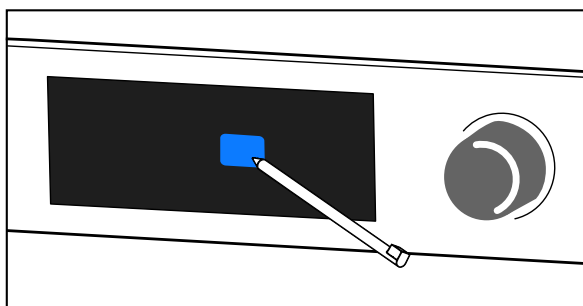

Returning to the previous screen:

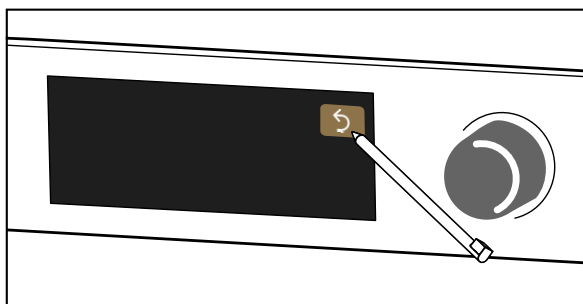

Unlocking the display

The interface can be locked and unlocked in LA Network Manager to prevent unintentional operations.

When the interface is locked, actions on the touchscreen display, and turns and short presses of the encoding wheel are ignored. Instead the screen shows **Display locked**.

To unlock from the physical unit, press and hold the encoding wheel for about two seconds. The screen shows **Display unlocked**.

Using the main screen

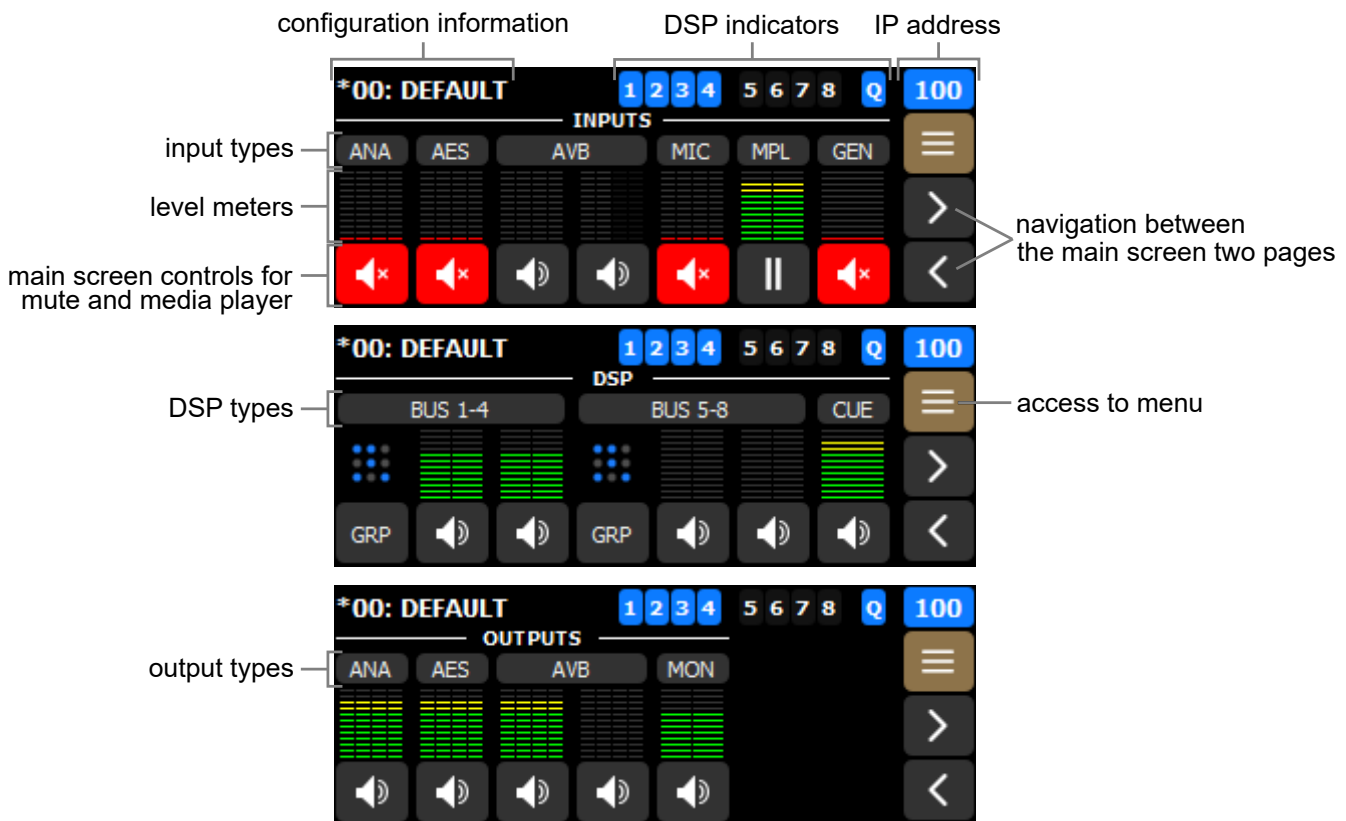

Configuration information

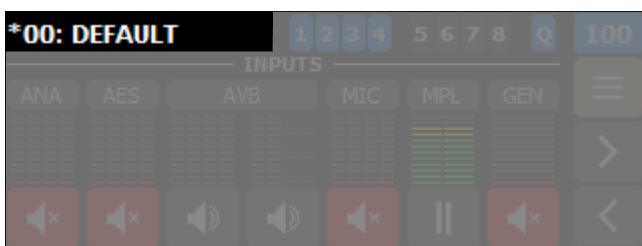

- * (star sign): indicates unsaved modification
- memory space number: from 01 to 30
- configuration name

Refer to the [Configurations](#) (p.54) menu.

DSP indicators

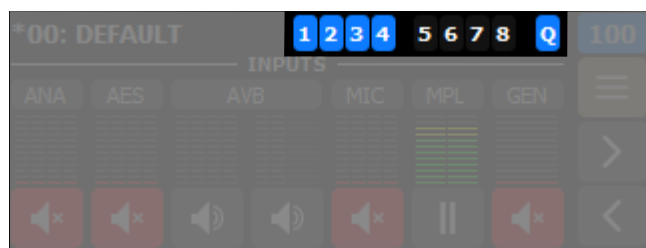

- **1** to **8** are DSP BUS indicators.
- **Q** is the CUE BUS indicator.

- 1** Bus is routed to at least one output.
- 1** Peak sample limiter is active (refer to [Level meters and mute](#) (p.28)).
- 1** Bus is not routed to any output.

IP address

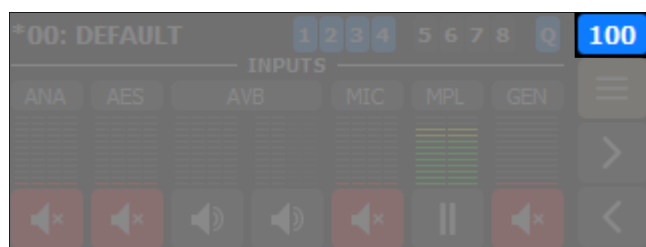

This number corresponds to the last number of the P1 IP address (from 1 to 254). Refer to [Configuring the IP settings](#) (p.71).

- 100** P1 is not connected to LA Network Manager, or to any L-COM based remote controller.
- 100** P1 is connected to an L-COM based remote controller, but not to LA Network Manager.
- 100** P1 is connected to LA Network Manager, and may be also connected to another L-COM based remote controller.

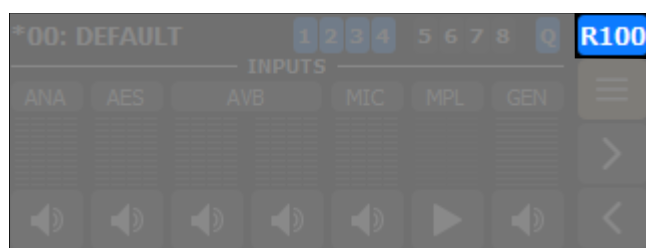

R is displayed in front of the IP address when redundancy mode is enabled. Refer to [Configuring the network switch](#) (p.66).

Level meters and mute

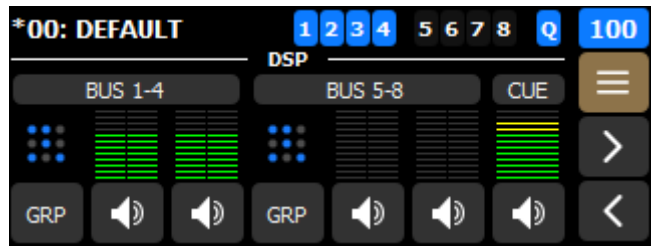
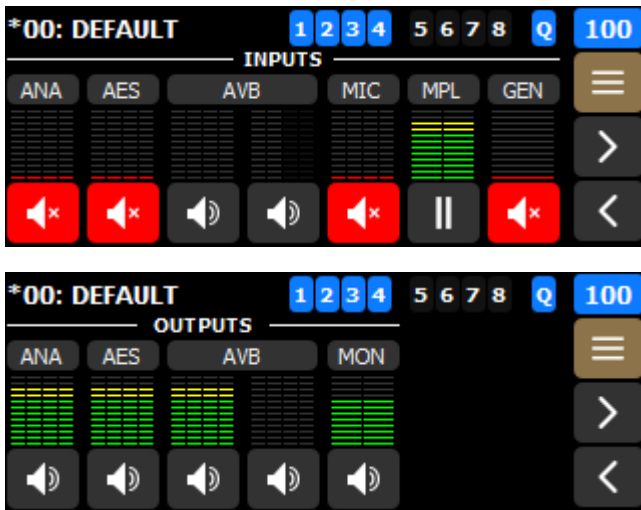



Main screen level meters

- red Digital level is between -5 and 0 dBFS (peak sample limiter on BUS and CUE signals).
- yellow Digital level is between -20 and -5 dBFS.
- green Digital level is between -60 and -20 dBFS.

i Level meters can be gray, blue, or orange in fallback scenarios.

Refer to [Automatic input fallback](#) (p.30).

Main screen mute

 /  Mute/Unmute all signals in the corresponding set of four input/output.

Example with muted ANA, AES, MIC and GEN:

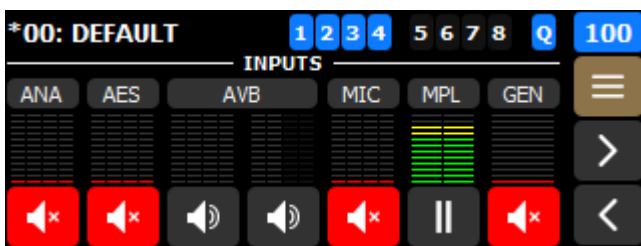

 Red bottom indicators represent a muted signal.

 On muted inputs, pre-mute levels are displayed above the red bottom indicator.

 Orange mute buttons represent a mixed status across a single input/output type.
For individual signal mute, refer to [Mute](#) (p.35).

For confirmations before applying the main screen mute/unmute, refer to [Selecting preferences](#) (p.68).

Time-alignment

i Time-alignment can only be configured in LA Network Manager.

The AES/EBU and analog outputs of P1 are always time-aligned.

When a P1 unit is used as a front-end processor to feed LA12X, compatible LA4X, or other P1 units using AVB for the main distribution and AES/EBU or analog for the redundant distribution, it is recommended to enable Time-alignment for this P1 unit in LA Network Manager.

Time-alignment adds a small delay to the AES/EBU and analog outputs to align them to the AVB distribution, to compensate for the AVB network latency, and ensure the propagation time is the same on the AES/EBU, analog and AVB paths. This additional delay eliminates the risk of destructive interference due to time misalignment in case of partial loss of the main distribution.

To use this option, make sure that no equipment is inserted in the AES/EBU or analog path between the P1 used as a front-end processor and the units it feeds.

When the option is enabled, the **ANA**, **AES**, and **AVB** output labels are purple on the main screen.

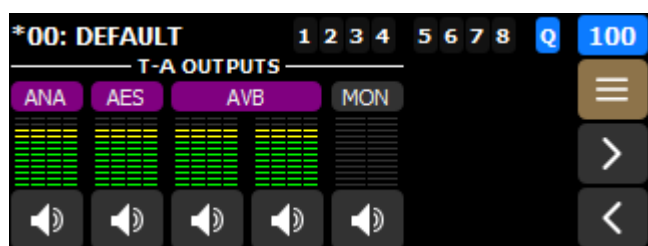

T-A on a purple background is also displayed in the respective output pages.

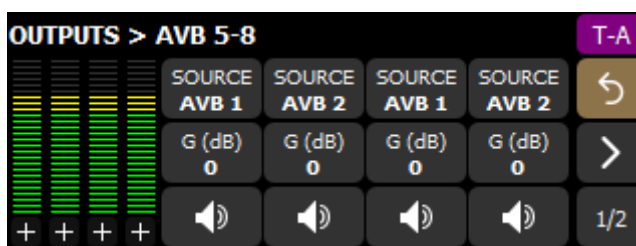
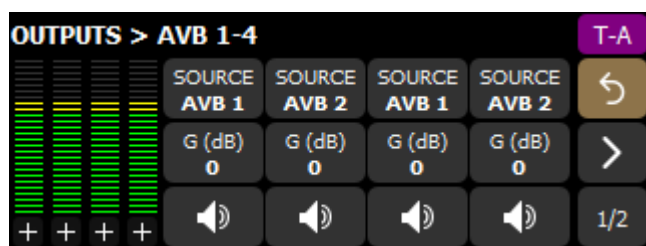
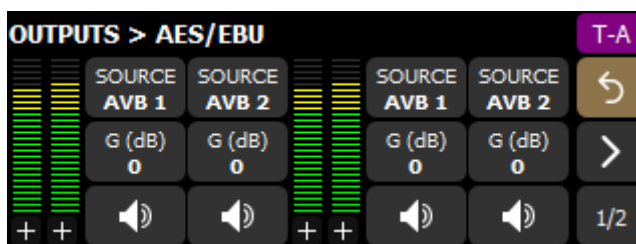
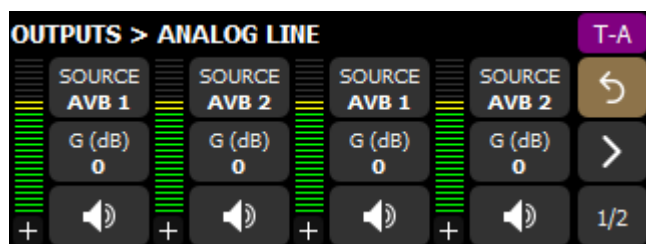

Automatic input fallback



Fallback can only be enabled and configured in LA Network Manager.

General considerations

When fallback is enabled, loss of sound due to signal failure in the AVB or AES inputs can be avoided by automatically switching to a fallback signal.

The switchover condition from an AVB signal is the loss of the "locked" status.

Possible causes:

- Switch or talker failure (rebooted, turned off, unplugged...).
- Cable failures.
- Disconnection or "stop streaming" requested by the AVB Controller.
- Non-Avnu certified device in the network.

The switchover conditions from an AES signal are:

- No clock
- Loss of lock
- CRC error
- Bipolar encoding error
- Data slip



Validity bit (invalid audio) value does not trigger a fallback.
Instead the signal is muted.



Precautions to avoid loss of sound or level differences upon fallback

The fallback input(s) must be connected to an audio source playing the same program as the main input.

The level of an AVB or AES audio source used as main input must be aligned (using gain) to the level of an analog audio source used as fallback input.



Fallback and time-alignment

The propagation time of the AVB signal distribution is likely to be longer than the propagation time of the AES/ EBU or ANALOG redundant signal distribution. In this case, if some Units in the system switch to AVB fallback, but not other Units, parts of the system are no longer time-aligned.

It is highly recommended to adopt a system deployment that minimize these risks, and to use the Trigger Fallback button in LA Network Manager on Units that did not switch over in order to re-align the system until the initial cause of the problem is found and resolved.

If the connected signal source comes from another P1, enable the time-alignment option in LA Network Manager to solve the issue.

Main inputs	Inputs available as fallback
AVB 1-4	<ul style="list-style-type: none"> • AES 1-4 • ANA 1-4 • MIC 1-4
AVB 5-8	<ul style="list-style-type: none"> • AES 1-4 • ANA 1-4 • MIC 1-4
AES 1-2	<ul style="list-style-type: none"> • ANA 1-2 • MIC 1-2
AES 3-4	<ul style="list-style-type: none"> • ANA 3-4 • MIC 3-4



A fallback input can be used twice.

For example, ANA 1-4 can be the fallback of both AVB 1-4 and AVB 5-8.

Crossed combinations are not possible.

For example, it is not possible for MIC 3-4 to be the fallback of AES 1-2.

Inputs designated as fallback are reserved for this usage, and therefore can no longer be selected as sources in the router.

Representation on main screen

When enabled, fallback is automatically triggered by both partial or total failures.

Reverting to the initial input after recovery is managed by manual selection in LA Network Manager.

In these examples, the main input is AES, and the fallback input is ANA.

Nominal	<p>The interface shows the 'INPUTS' section with buttons for ANA, AES, AVB, MIC, MPL, and GEN. The AES button has a blue border and a blue label. The ANA button has a blue label. Below the buttons are level meters for each input, with AES showing active channels in light gray and ANA showing inactive channels in light gray. There are also speaker icons and a play button.</p>	<p>Main input: Type label is blue. Fallback input: Type label has a blue frame, levels are light gray (displayed for monitoring and gain adjustment)</p>
Partial failure	<p>The interface shows the 'INPUTS' section. The AES button now has a red label. The ANA button has a blue label. The level meters for AES show some channels in blue (activated) and some in light gray (inactive). The ANA level meters remain in light gray.</p>	<p>Main input: Type label is red. Fallback input: Type label is blue. Levels of activated channels are blue, levels of channels that remain inactive remain light gray.</p>
Total failure	<p>The interface shows the 'INPUTS' section. The AES button has a red label. The ANA button has a blue label. The level meters for AES show all channels in blue. The ANA level meters remain in light gray.</p>	<p>Main input: Type label is red. Fallback input: Type label and levels of activated channels are blue.</p>
Partial recovery	<p>The interface shows the 'INPUTS' section. The AES button has a red label. The ANA button has a blue label. The level meters for AES show some channels in orange (recovered) and some in blue (activated). The ANA level meters remain in light gray.</p>	<p>Main input: Type label is red., levels of recovered channels are orange. Fallback input: Type label and levels of activated channels are blue.</p>
Total recovery	<p>The interface shows the 'INPUTS' section. The AES button now has an orange label. The ANA button has a blue label. The level meters for AES show all channels in orange. The ANA level meters remain in light gray.</p>	<p>Main input: Type label and levels of recovered channels are orange. Fallback input: Type label and levels of activated channels are blue.</p>

Using the input/output pages

Access to the input/output pages through their types or level meters.

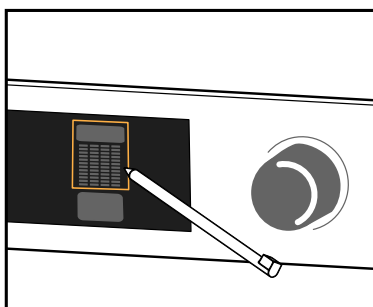

Inputs

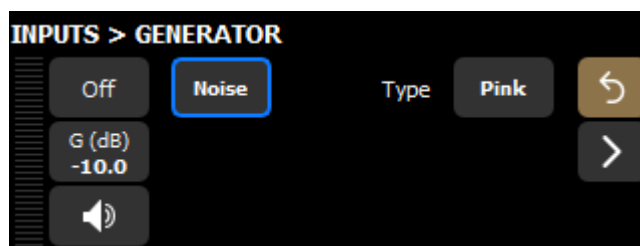
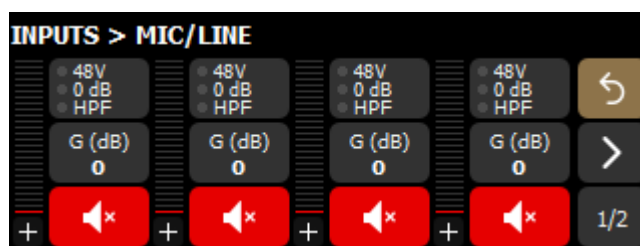
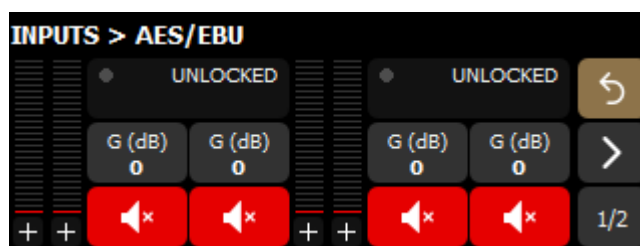
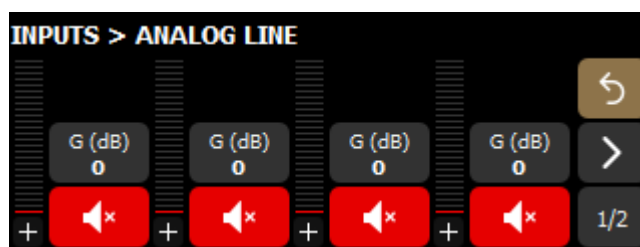
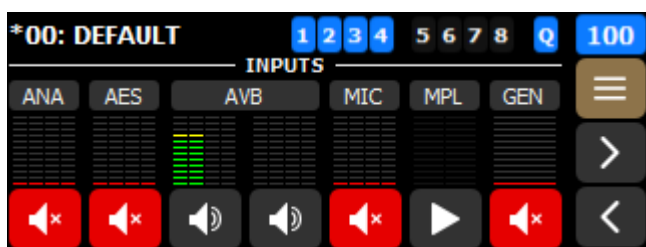

For the Media Player, refer to [Turning on the Media Player](#) (p.68).

DSP BUS

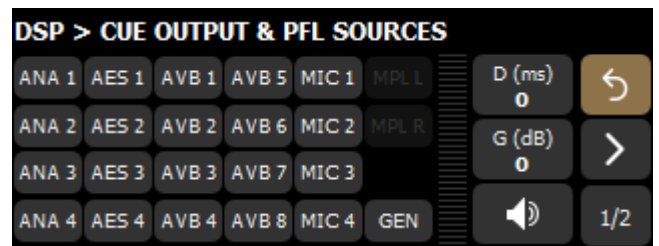
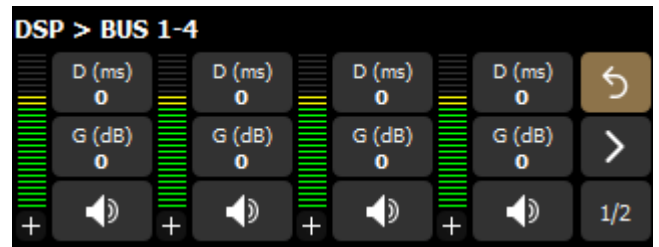
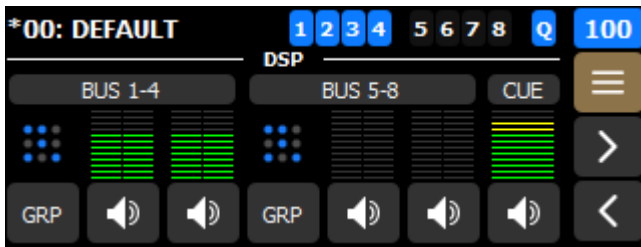

Outputs

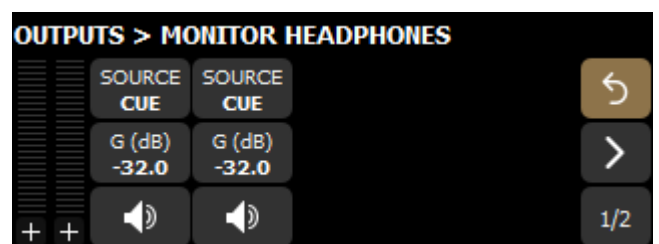
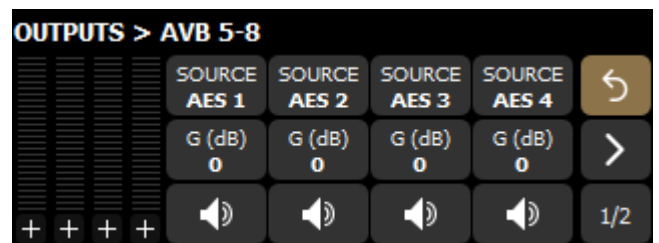
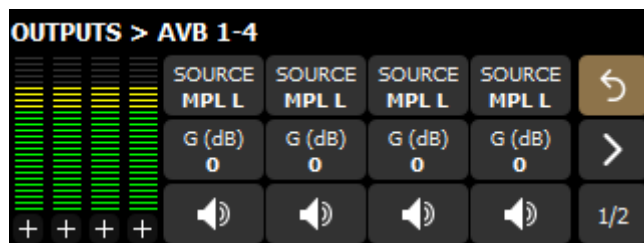
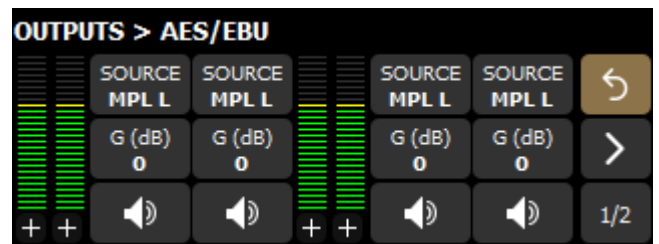
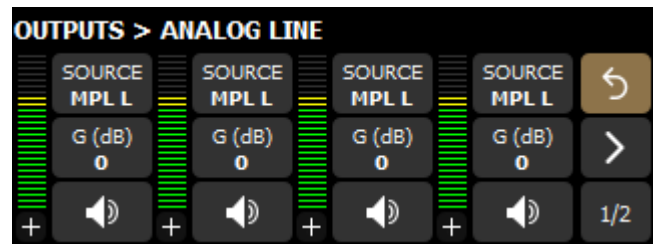
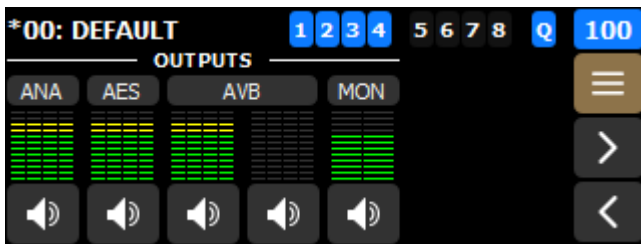

Stacked views

All pages (except Generator and Media Player) have stacked views to access additional settings and information, such as polarity, and AVB status and mapping.



Access to stacked views.

Example with the AVB outputs page:

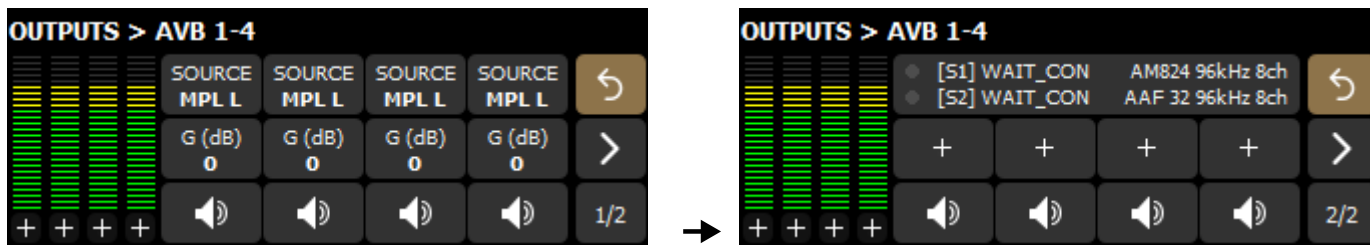

Mute

All pages have individual mute for each signal.

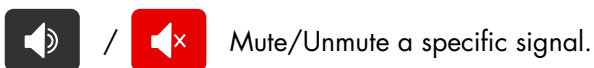

Mute/Unmute a specific signal.

When muted, the bottom indicators of the level meters are red.

Example with muted ANA 2 and ANA 4 outputs.

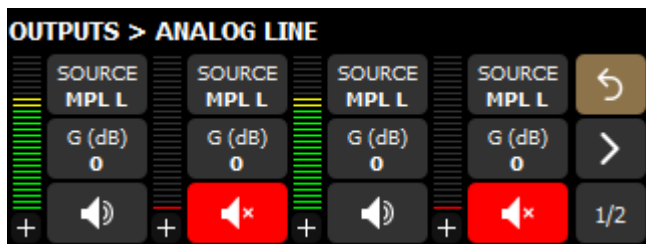

On the main screen, an orange mute represents a mixed status across a single input/output type.

Gain

All pages have individual gain for each signal.

This is a digital gain (post-conversion on analog signals). For additional analog preamp gain on Mic inputs, refer to [Mic/Line settings](#) (p.43).

G (dB)
0 Edit gain for a specific signal.

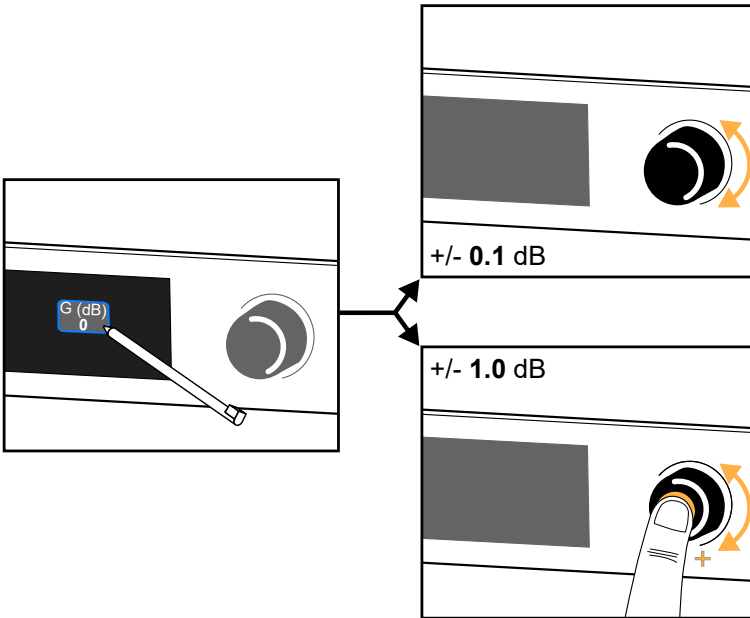

To select whether selections are additive (multiple selections) or exclusive (one item at a time), refer to [Selecting preferences](#) (p.68).

Polarity

All pages (except Generator, Media Player, and CUE BUS) have individual polarity settings for each signal, accessible in a stacked view (view 2).

 Polarity of the corresponding input or output type.

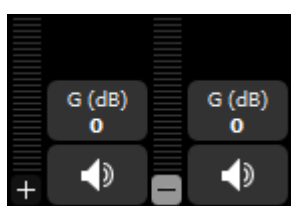
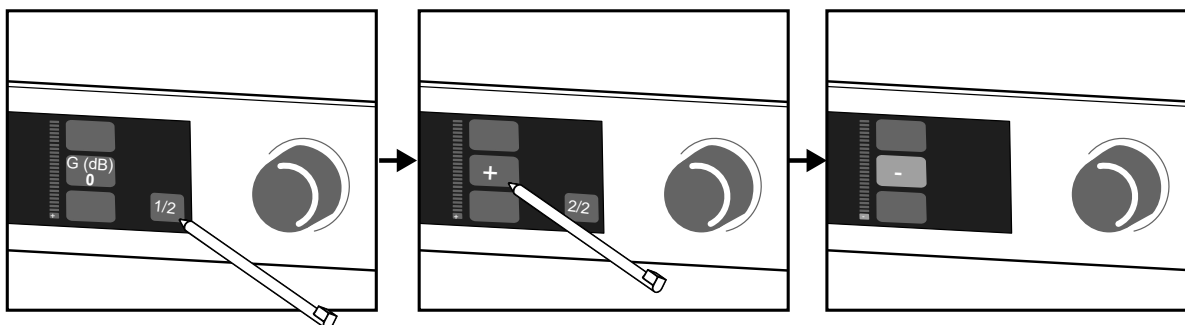

On both views of the page, the polarity status is at the bottom of the level meters.

Signal status (AES and AVB)

The status of the signal is displayed on the AES/EBU input page, and in the AVB input and output pages.

AES/EBU status

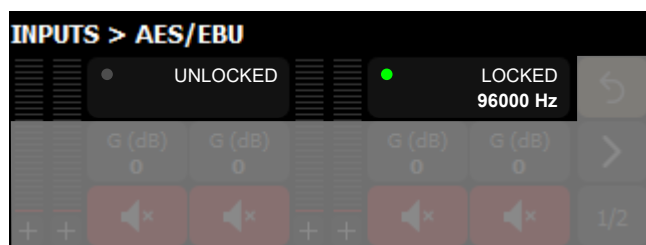

LOCKED and the sampling frequency

Indicates a digital audio source is connected to the AES/EBU inputs, the signal delivered by the source has a format supported by the processor's digital audio board, and no loss or fault is being detected during data transfer.

For example, **LOCKED 96000 Hz** indicates the digital audio source provides signals of sampling frequency of 96 kHz.

UNLOCKED

Indicates the incoming digital signals are faulty and leads to loss of audio.

The LOCKED status is re-acquired after at least 500 ms of stability.

INVALID

Indicates non-audio data in the payload or errors in the AES/EBU transmission.

Input AVB statuses

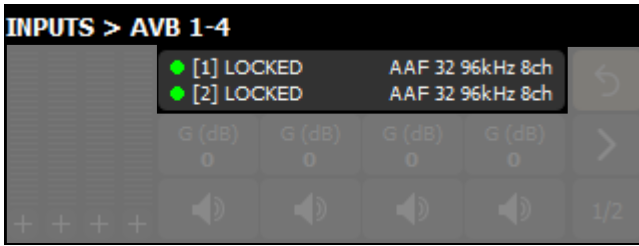

IDLE	<p>The unit is not connected to any talker.</p> <p>If unexpected, possible cause is that an AVB controller requested a disconnection.</p> <p>To resolve, connect an AVB controller and use it to connect the unit to a talker.</p>
WAITING TLKR / WAIT TLKR / WTLK	<p>The listener has been told by an AVB controller to connect to a talker and it is now waiting for the talker to be online.</p> <p>If displayed for more than a few seconds:</p> <ul style="list-style-type: none"> • Check the network for a disconnected cable. • Check that the talker is in working order (fully booted).
CONNECTING / CING	<p>Temporary status while the listener waits for the talker to send information about the stream.</p>
CON TIMEOUT / CTMO	<p>Timeout has been reached while the listener waits for the talker to send information about the stream.</p> <p>Check that there are no issue on the network such as firewall parameters or Wi-Fi access points.</p>
CONNECTION ERROR / CON ERROR / CERR and error code	<p>While the listener waited for the talker to send information about the stream, the talker reported an issue.</p> <p>Refer to the Appendix C - List of AVB connection (CON) errors (p.88).</p>
WAITING RSV / WAIT RSV / WRSV	<p>The listener is waiting for the conclusion of the bandwidth reservation from the talker.</p>
RESERVATION ERROR / RSV ERROR / RERR and error code	<p>The bandwidth reservation has failed.</p> <p>It can also be temporarily displayed when a network cable is disconnected then reconnected.</p> <p>Refer to the Appendix B - List of AVB reservation (RSV) errors (p.86).</p>
WAITING START / WAIT START / WSRT	<p>The bandwidth is reserved but the unit has received a "stop streaming" command by the AVB controller: Try disconnecting and reconnecting the stream.</p>
WAITING DATA / WAIT DATA / WDAT	<p>Waiting for the talker to transmit the stream.</p> <p>If displayed for more than a few seconds, possible causes are:</p> <ul style="list-style-type: none"> • Talker is physically disconnected or off: check the talker. • A "stop streaming" command has been sent to the talker from a third-party AVB controller: Try disconnecting and reconnecting the stream.
DATA ERROR / DERR	<p>The listener is receiving the stream from the talker but the format is not as announced by the AVB controller.</p> <p>Check that the controller is sending the correct information.</p>
VALIDATING / VLDT	<p>The listener is receiving the stream from the talker, the stream has the correct format and the listener is verifying the validity of the time synchronization information from the stream before processing it.</p> <p>If displayed for more than a few seconds, check the number of hops in the network cabling.</p>
READY and the sampling frequency	<p>Processing of audio is suspended.</p> <p>Temporary status between Validating and Locked.</p>

WAITING MCLK / WAIT MCLK / WMCK The listener cannot process audio from this stream because the currently selected media clock source is not providing a valid clock.
Possible cause is: Non-Avnu certified devices on the network are disrupting the media clock synchronization. Preferably use Avnu-certified devices.

LOCKED / LCK and the sampling frequency Processing audio stream data.
If the AVB status dot is orange, check the settings of the media clock source.

Output AVB statuses

In the AVB output page, the signal status is visible in the stacked view 2 (refer to [Stacked views](#) (p.35)).

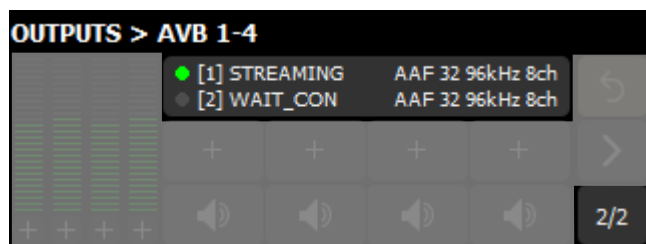

IDLE Temporary status at startup.

WAITING DSTAD The talker is performing dynamic allocation of a Destination MAC Address for the output stream.
If unexpected, check the network for faulty devices.

WAIT CON The talker is ready to receive a connection request from a listener.
If unexpected: use an AVB controller to check that a listener has been instructed to connect to the talker.

WAIT REUSE The talker has received a connection request but needs to wait (max. 30 seconds) for the SRP protocol to release a previous reservation for the stream, because of a change in the stream format or stream latency.

WAIT RSV The talker is waiting for the conclusion of the bandwidth reservation from a listener.
If displayed for more than a few seconds:

- Check the network for a disconnected cable.
- Check that the listener is in working order (fully booted).

RESERVATION ERROR The bandwidth reservation has failed.
It can also be temporarily displayed when a network cable is disconnected then reconnected.
If displayed for more than a few seconds, check the [Appendix B - List of AVB reservation \(RSV\) errors](#) (p.86).

READY and the sampling frequency Waiting for media clock to set up.
If displayed for more than a few seconds, possible cause is: Non-Avnu certified devices on the network are disrupting the media clock synchronization. Preferably use Avnu-certified devices.

STREAMING and the stream format Sending audio stream data.

Mapping (AVB)

In the default configuration, the channels from the first AVB input stream are directly mapped to the P1 AVB inputs, and the P1 AVB outputs are directly mapped to the first AVB output stream.

Using mapping, it is possible to patch any channel from the input streams to any P1 AVB input, and any P1 AVB output to any channel in the output streams.

To access the respective mappings, use the individual inputs in the AVB input pages and the signal status in the AVB output pages (in the stacked view 2).

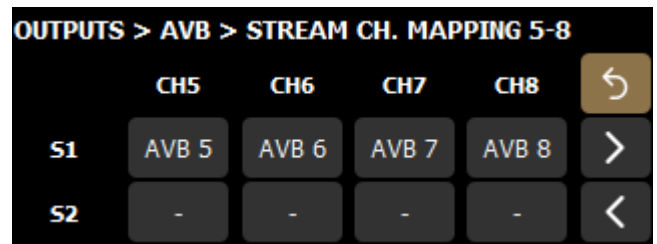
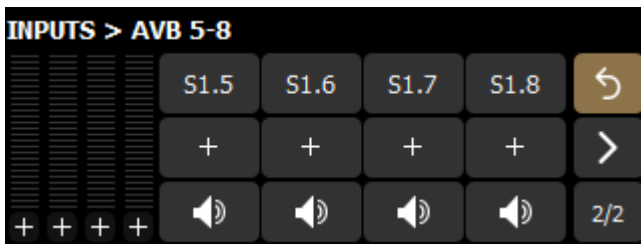
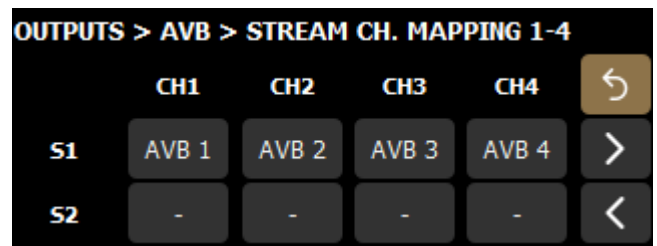
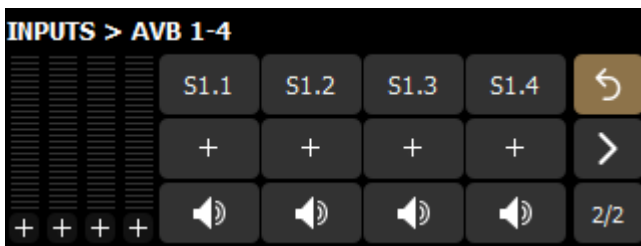
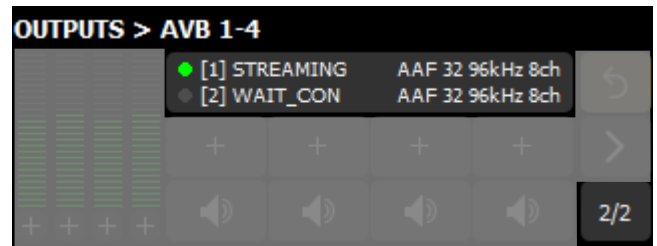
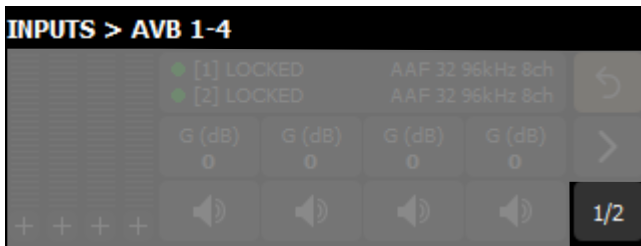

In redundancy mode:

- It is only possible to patch a channel from the primary stream to a P1 AVB input. The mapping is automatically applied to the secondary stream input.
- Mapping for the secondary stream output cannot be edited, because the mapping of the primary stream output is automatically applied to the secondary stream output.

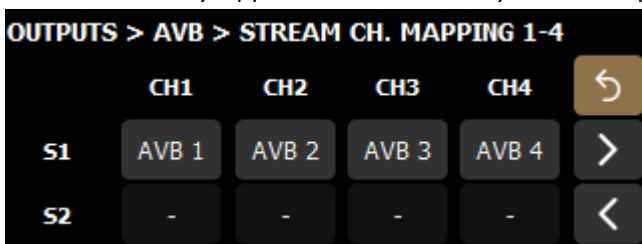

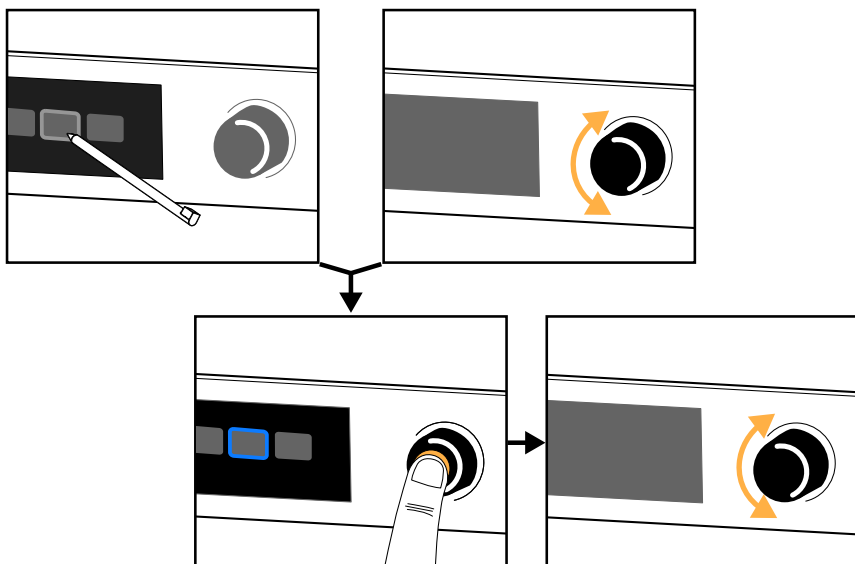

Each AVB input can receive one of the eight channels of an input stream. Each channel of the output streams can be fed from any P1 AVB output.

Normal mode

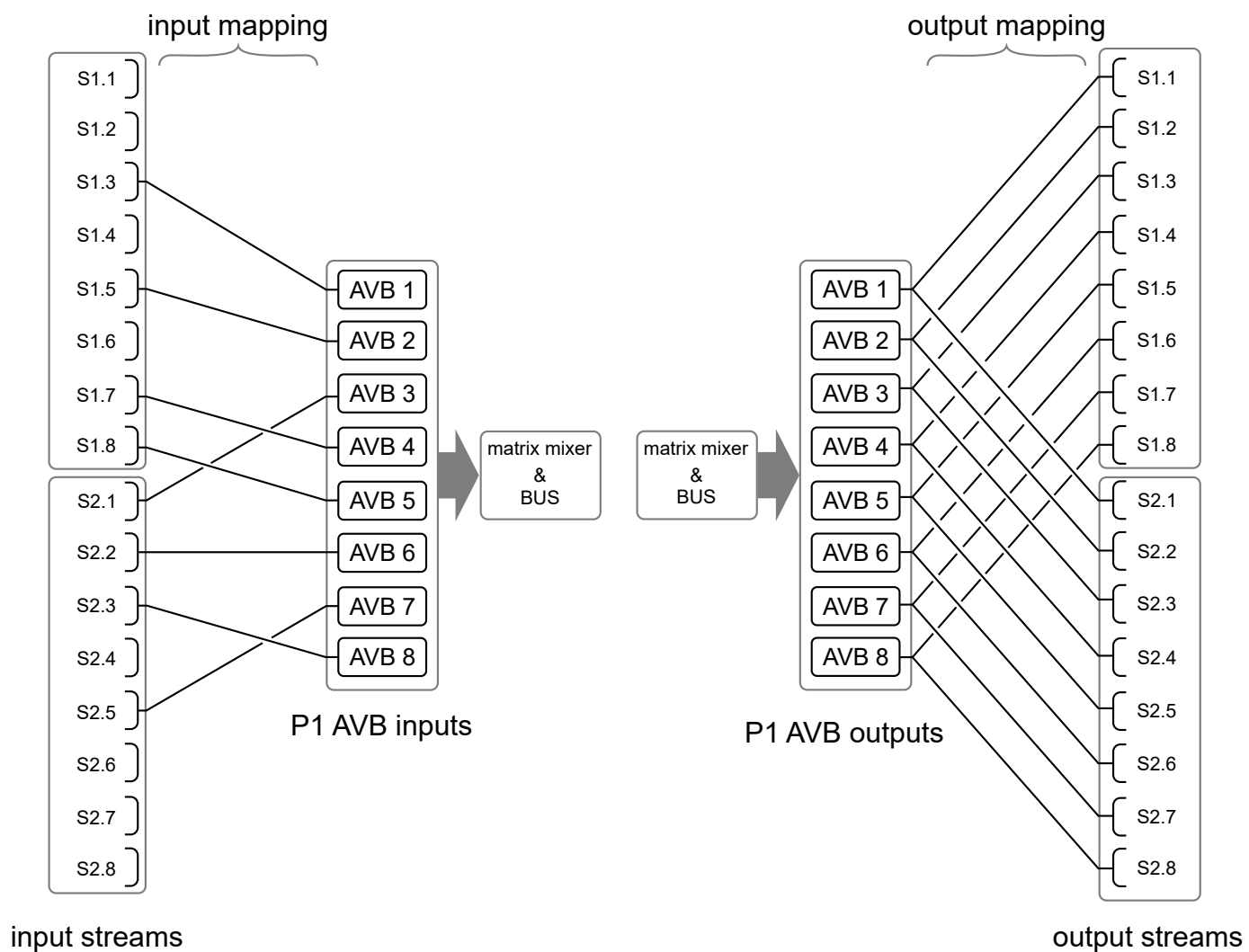

Redundancy mode

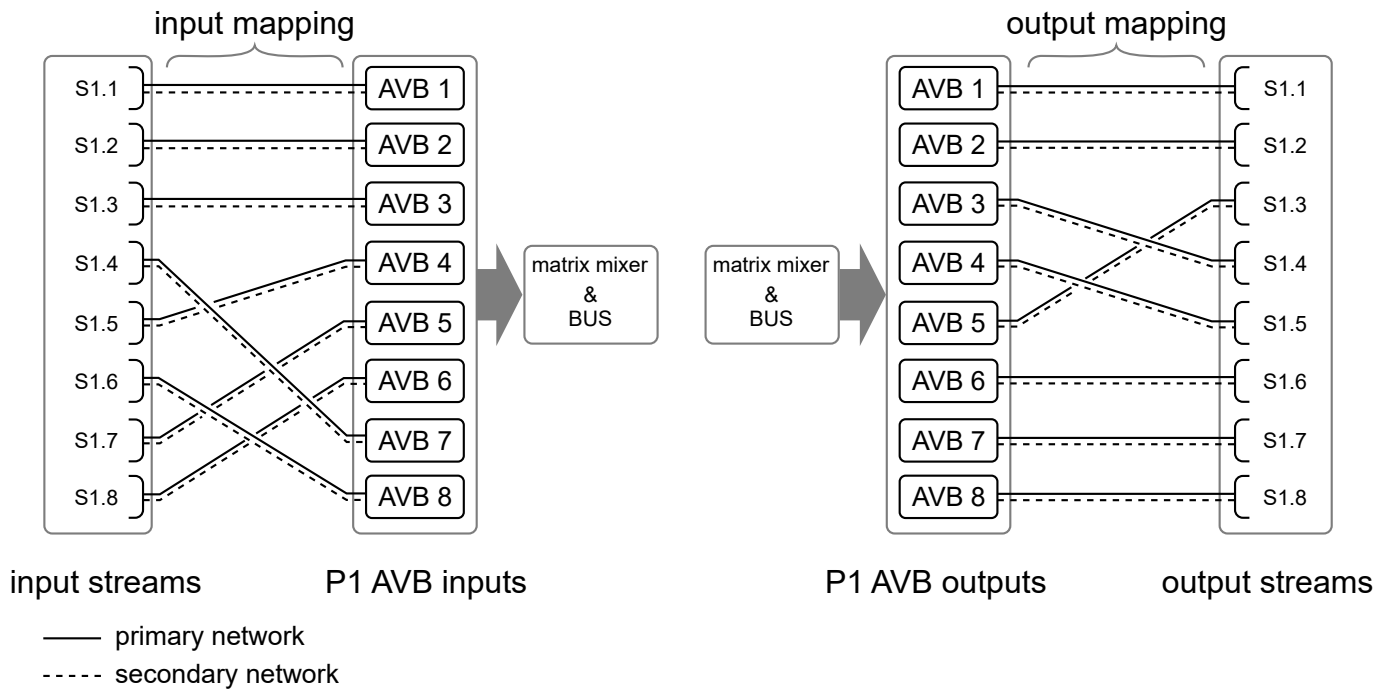

Sampling frequency (AES)

The AES output page have a sampling frequency setting for each signal, accessible in a stacked view (view 2).

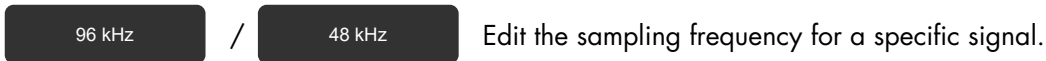

The default value is 96 kHz, but the setting can be edited to 48 kHz to enable long cable runs (up to 300 m) with selected AES/EBU rated cables.

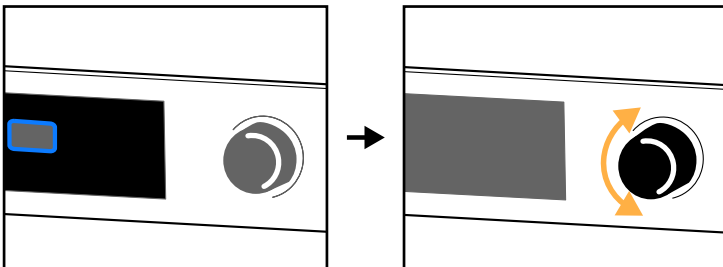

Example with AES 1/2 at 48 kHz and AES 3/4 at 96 kHz.

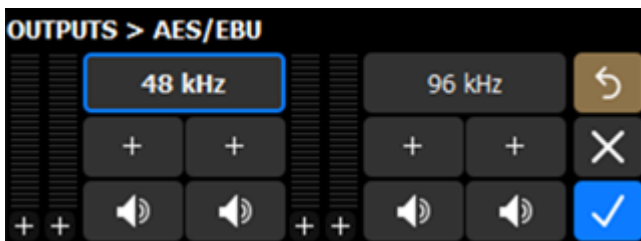

Mic/Line settings

The mic/line page has three settings for each input.

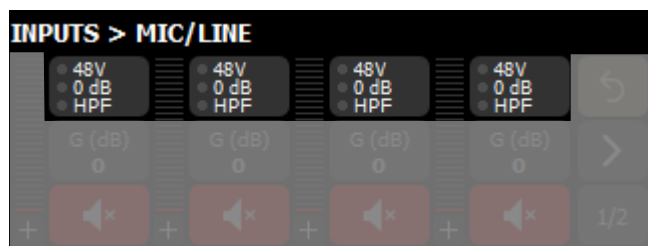

48V
0 dB
HPF Edit settings for a specific mic/line input.

Phantom Power (48V)

Off / On

→ 48V
0 dB
HPF

Preamp Analog Gain (dB)

0

from 0 dB to +60 dB

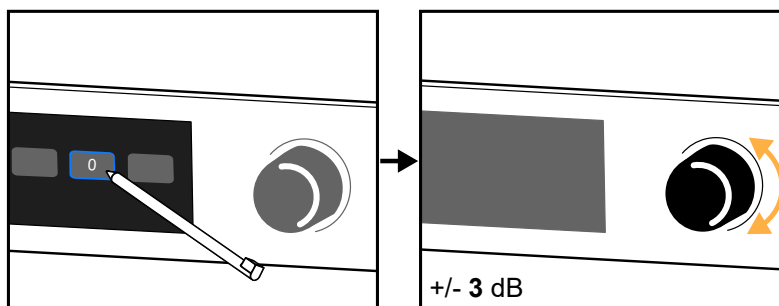

→ 48V
+3 dB
HPF

High-pass Filter (40Hz)

Off / On

→ 48V
0 dB
HPF

Media Player (MPL)

Turn on the Media Player in the Options, refer to [Turning on the Media Player](#) (p.68).

i Turning on the Media Player disables AVB inputs 7 and 8.

Use the Media Player to read audio files from a USB drive connected to one of the USB ports.

P1 supports USB drives using the FAT 16 or FAT 32 file system.

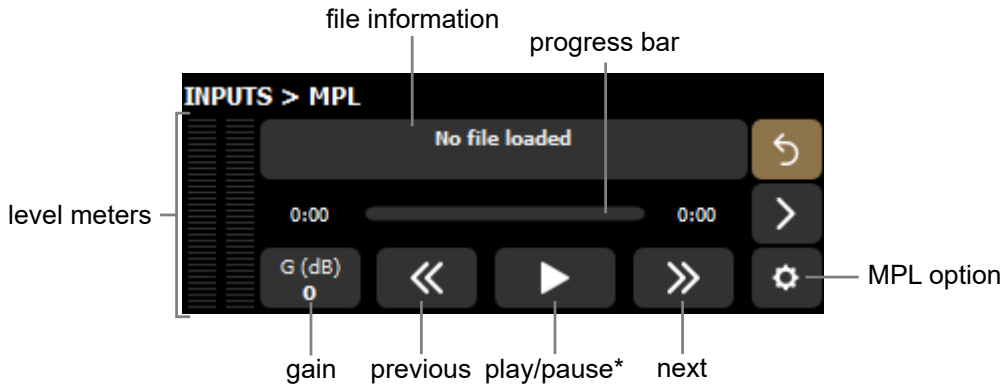

* Also available on the main screen.

Selecting a file

In the Media Player page, use **No file loaded** to select an audio file from a connected USB drive.

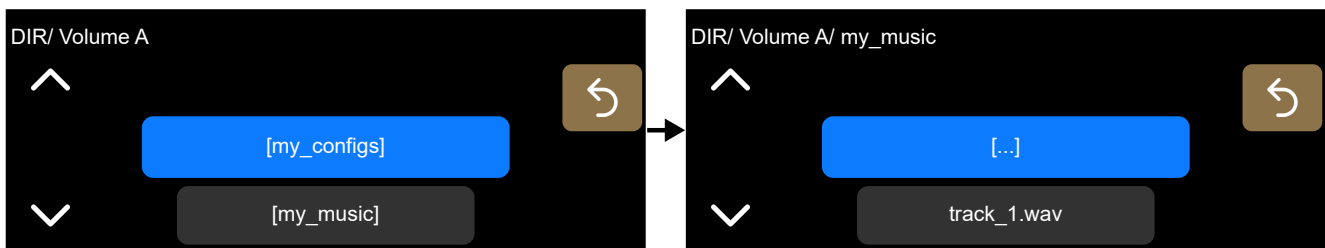

Supported file formats: *.aif, *.aiff, *.caf, *.flac, *.m4a, *.wav.

Supported audio formats:

- ALAC, FLAC, PCM
- 44.1 kHz to 192 kHz for mono files, 44.1 kHz to 96 kHz for stereo files
- from 16 bits to 32 bits

Stereo output is operating at 24 bits/96 kHz, with automatic high-quality SRC if the sampling frequency (Fs) is different from 96 kHz. Mono files are played to both outputs of the Media Player.

MPL options

The Media Player page has an option button.



Open the Media Player options.

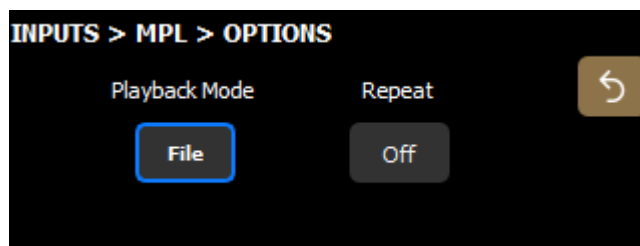
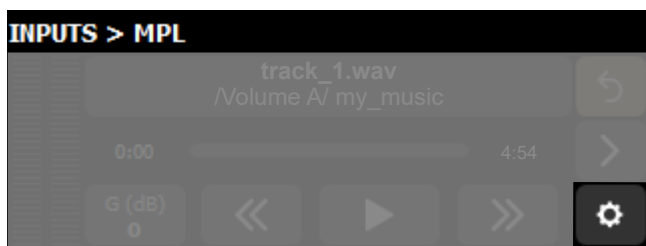

Playback Mode

file play a single file

folder play all files in the folder

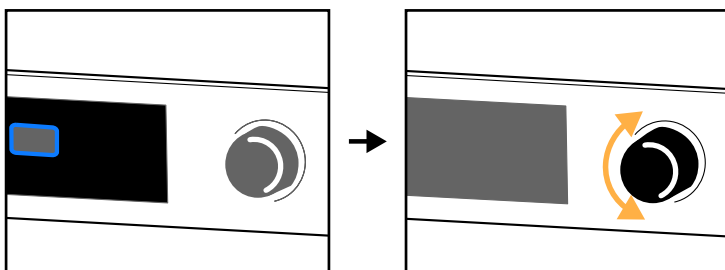

Repeat



/



Turn off/on the repeat option (file or folder played once or on loop).

Generator

Configure the signal generator in the Generator page.

Signal types: sine wave, sine bursts, 20 Hz-20 kHz sweep, white noise, and pink noise.

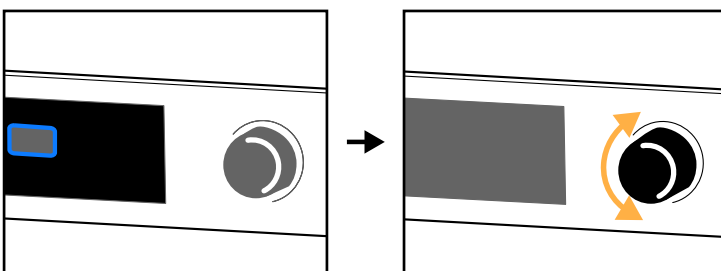
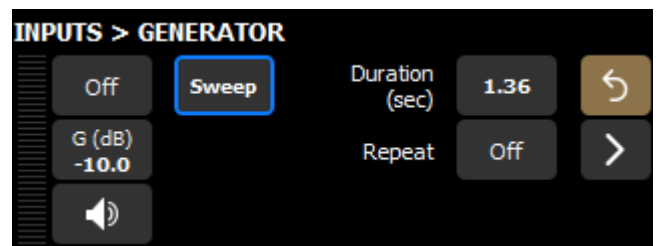
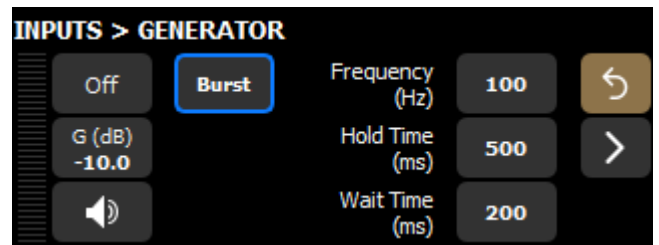
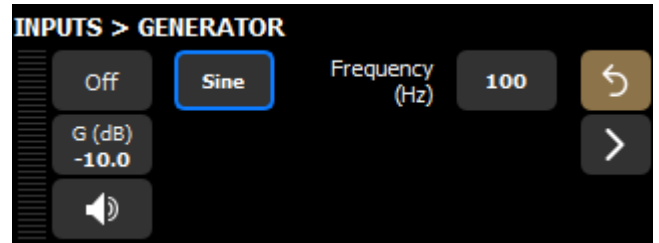
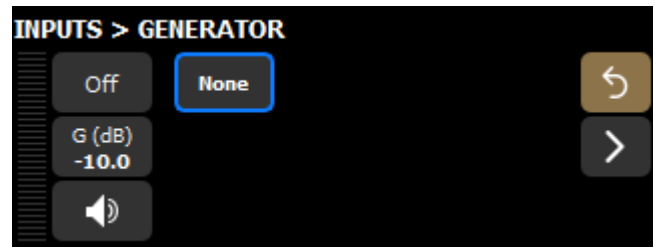
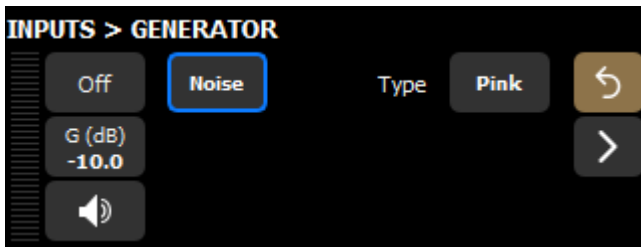

i It is possible to modify the frequency of sine wave when the signal is on.

Repeat (Sweep)

Off / **On** Turn off/on the repeat option (signal played once or on loop).

i The repeat option can only be enabled when the generator is turned off.

DSP (BUS and CUE)

Matrix mixer view (DSP BUS)



Open the Matrix Mixer page.

The matrix mixer page displays a read-only recap of the matrix mixer.



The matrix mixer is configured in LA Network Manager.

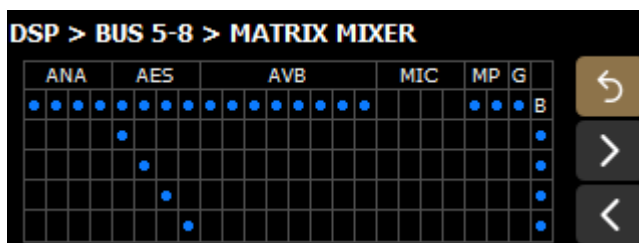
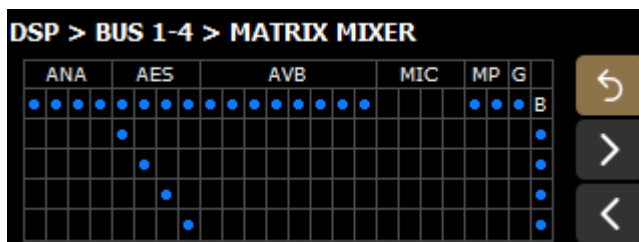
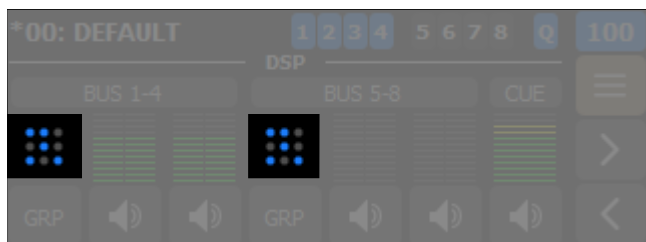

The blue dots represent what is enabled.

First row below the labels indicates enabled inputs, and last column indicates enabled busses. In this example, all inputs except MIC, and all busses are enabled.

Other intersections indicate which inputs are sent to the busses. In this example, AES 1 to 4 are sent to busses 1 to 4 and 5 to 8 respectively.

8x8 matrix alignment delay



8x8 matrix alignment delay is configured in LA Network Manager.

When two P1 processors are configured to create an 8x8 matrix, it is recommended to enable the 8x8 matrix option for these P1 units in LA Network Manager.

In an 8x8 matrix, AVB 5-8 is used to cross patch physical inputs between the two P1 processors, and AVB 1-4 is used to send the DSP busses to amplified controllers.

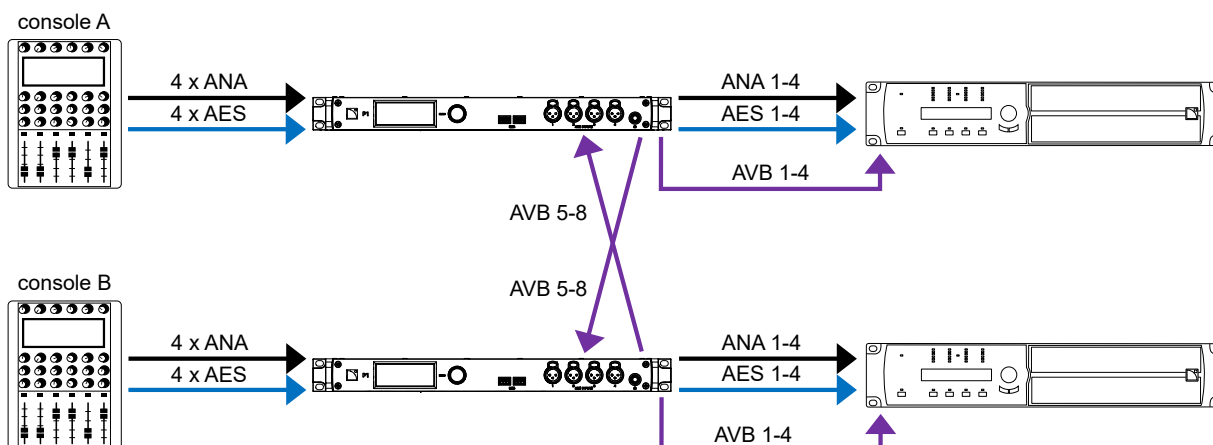

The 8x8 matrix option adds a small delay for the physical inputs of each P1 at the Matrix Mixer input stage to compensate for the AVB network latency, and to ensure that signals coming from any inputs to any bus are time-aligned.

To use this option, make sure that both P1 processors use the same media clock. Refer to [Media Clock](#) (p.60).

When the option is enabled, the **ANA** and **AES** labels on the Matrix Mixer page are purple and **8x8** on a purple background is displayed on the Matrix Mixer and DSP BUS page.

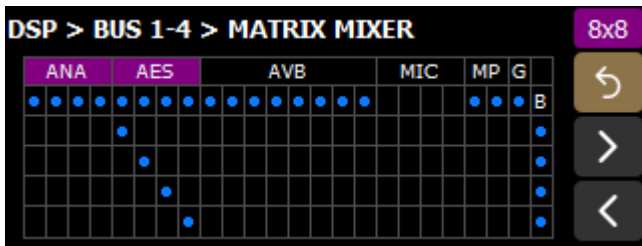

Delay

The DSP BUS and CUE BUS pages have a delay setting, accessible in both stacked views.

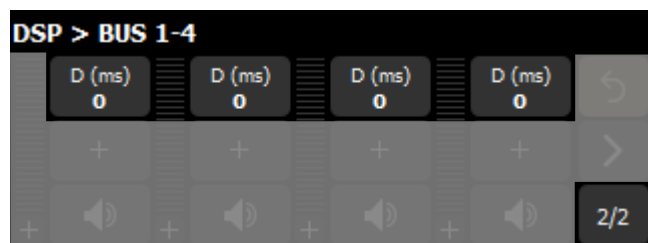
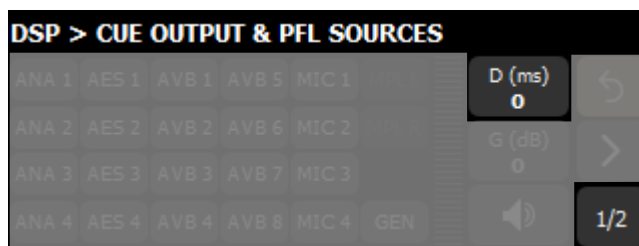
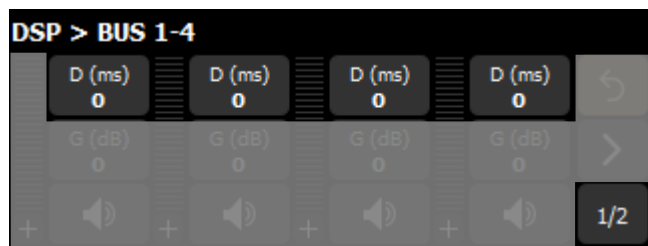

D (ms) 0 Edit delay.

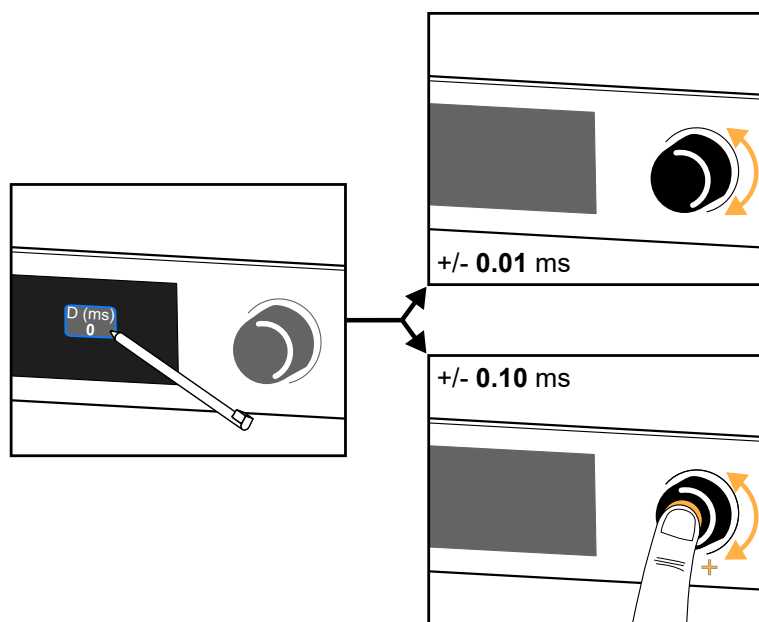

Tap and hold to open the numeric keypad.

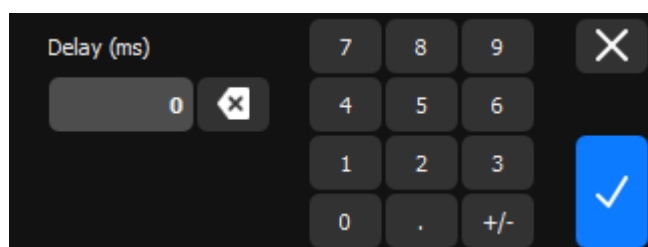

Maximum delay for the CUE BUS is 2000 ms.

Maximum delay for each DSP BUS is 2000 ms, in addition to group delay. Refer to [Group Parameters \(DSP BUS\)](#) (p.50).

Group Parameters (DSP BUS)

GRP

Open the Group Parameters page.

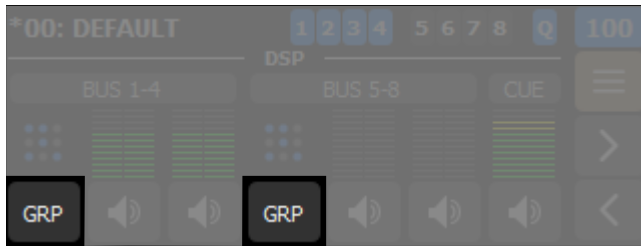

DSP > GRP 1-4			
NAME	NAME	NAME	NAME
Group 1	Group 1	Group 2	mult_grp
GAIN	GAIN	GAIN	GAIN
+3,0 dB	+3,0 dB	+3,0 dB	+6,0 dB
DELAY	DELAY	DELAY	DELAY
0,00 ms	0,00 ms	0,00 ms	0,00 ms
EQ	EQ	EQ	EQ
On	On	Off	On

DSP > GRP 5-8			
NAME	NAME	NAME	NAME
-	-	-	-
GAIN	GAIN	GAIN	GAIN
+0,0 dB	+0,0 dB	+0,0 dB	+0,0 dB
DELAY	DELAY	DELAY	DELAY
0,00 ms	0,00 ms	0,00 ms	0,00 ms
EQ	EQ	EQ	EQ
Off	Off	Off	Off

i For more information on how to create groups and edit their parameters (such as gain, delay, and EQ), refer to the LA Network Manager help.

Each DSP BUS output can be assigned to several groups. Group Parameters displays the group information for BUS 1 to 4 or BUS 5 to 8 respectively from left to right.

The information includes:

- The group name (if any).
- The group gain.
- The group delay.
- The EQ status (on or off).

In case of multiple group assignments:

- The name is **mult_grp**.
- The gain is the addition of the gains from all contributing groups.
- The delay is the addition of the delays from all contributing groups.
- The EQ status is on if at least one of the contributing groups has active EQ.

Maximum group delay is 2000 ms, in addition to individual DSP BUS delays. Refer to [Delay](#) (p.49).

AFL/PFL (CUE BUS)

The CUE BUS page displays PFL in the stacked view 1, and AFL in the stacked view 2 (refer to [Stacked views](#) (p.35)).

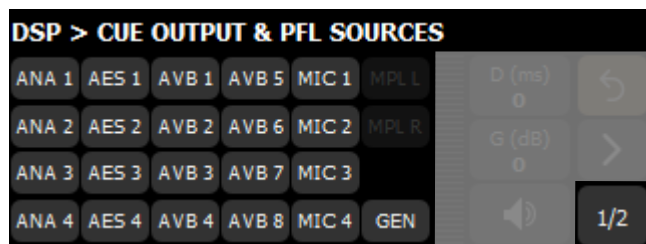

By default, the CUE BUS is routed to the monitor headphones. AFL and PFL allow isolating one or several input signals to monitor sound and mix quality for tuning purposes.

PFL (Pre-Fader Listening)

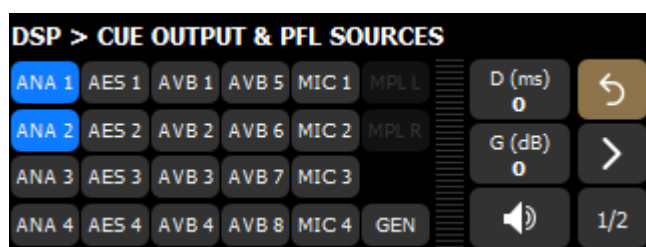

Select the input(s) to send to the CUE BUS.

All selected signals are summed. Input or DSP BUS gain is not applied.

AFL (After-Fader Listening)



Select the DSP BUS input(s) to send to the CUE BUS.

All selected signals are summed. Input and DSP BUS gain are applied.

Source selection

All output pages have an individual source selection.

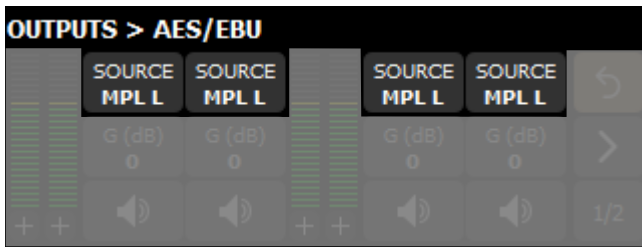

SOURCE Edit source selection for a specific output.

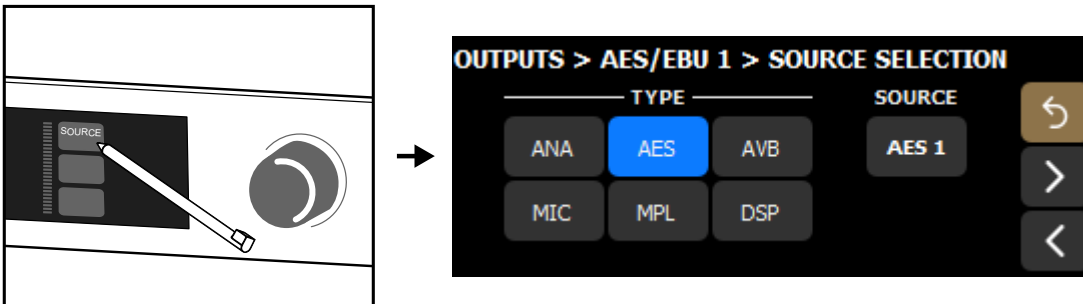

Select the type of source (ANA, AES, AVB, MIC, MPL or DSP), then select the source.

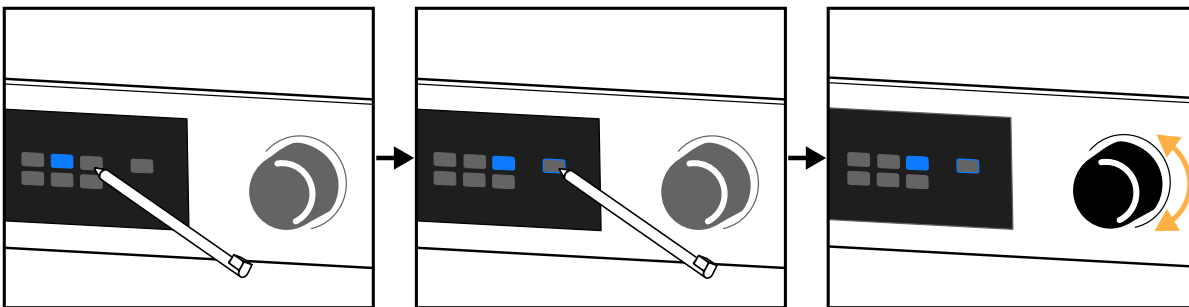

The source can come from one of the 20 input sources (4 analog, 4 AES, 8 AVB and 4 mic) or from one of the 10 DSP sources (8 BUS, 1 CUE and 1 Generator) - refer to [DSP architecture](#) (p.14).

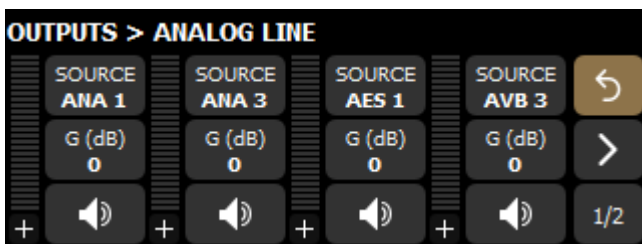

Example with inputs ANA 1, ANA 3, AES 1 and AVB 3 mapped to the four analog outputs.

AVB-7

i Inputs appear crossed out when unavailable.

AVB 7-8 are crossed out when disabled by the Media Player option. Refer to [Media Player \(MPL\)](#) (p.44).

AES, ANA and MIC are crossed out when designated as fallback. Refer to [Automatic input fallback](#) (p.30).

For a read-only recap of the source selection, refer to [Matrix mixer view \(DSP BUS\)](#) (p.47).

Using the menu



Open the menu (or push the encoding wheel from the main screen).

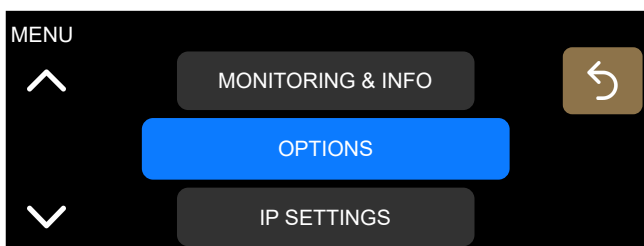
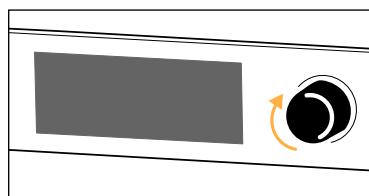
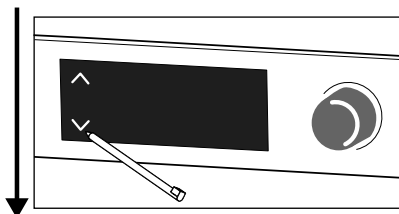
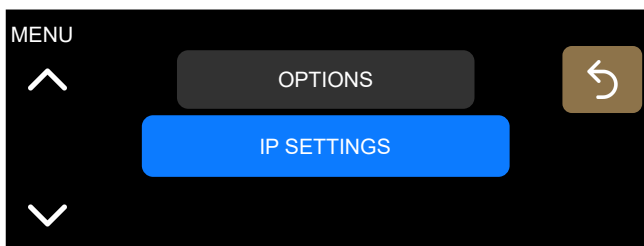
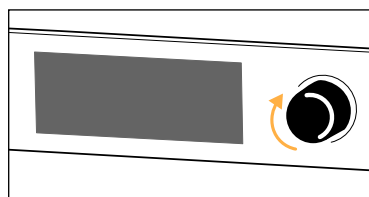
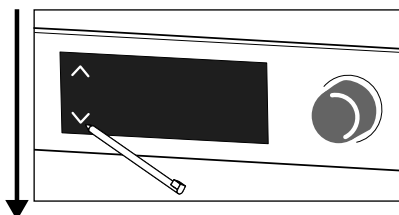
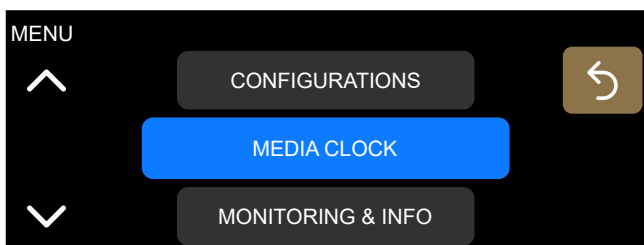
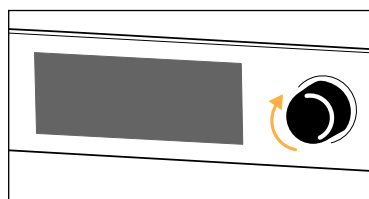
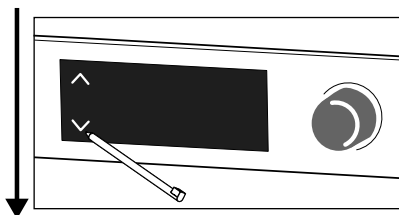
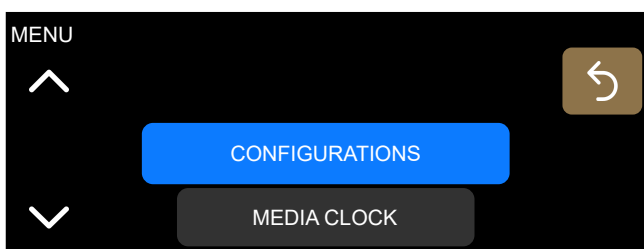

Configurations

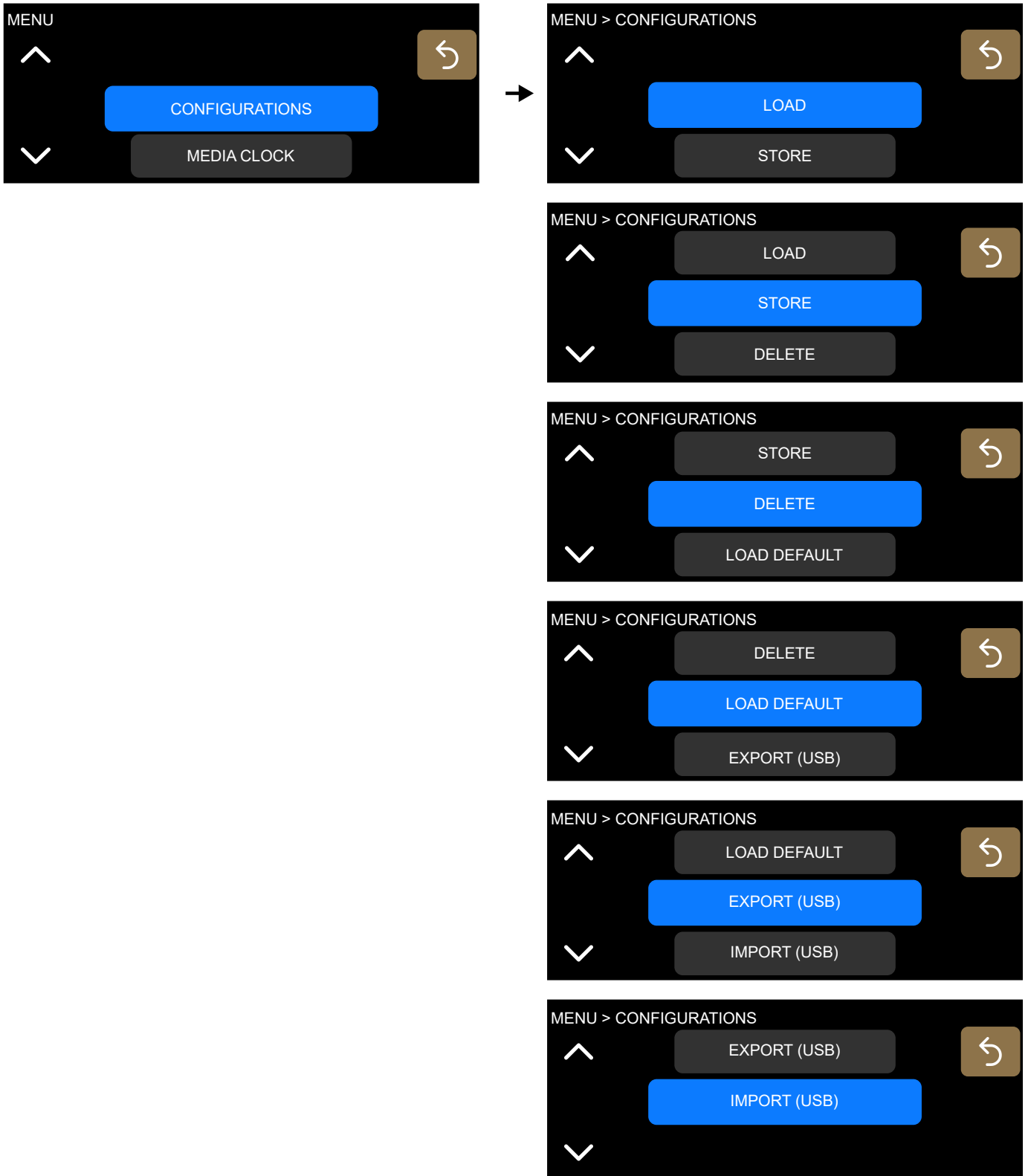

Access to the **Configurations** menu is disabled when LA Network Manager is connected.

Loading a configuration

Select **CONFIGURATIONS** > **LOAD**. Select from one of the previously stored configurations.

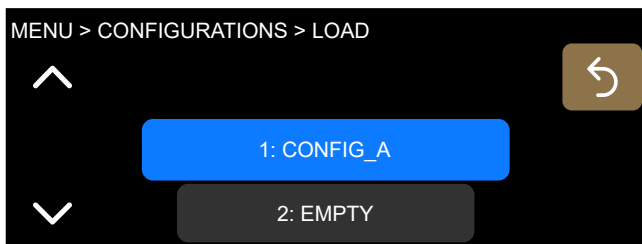

Storing a configuration

Select **CONFIGURATIONS** > **STORE**. There are 30 memory spaces.

Choose a name (16 characters maximum) for the configuration.

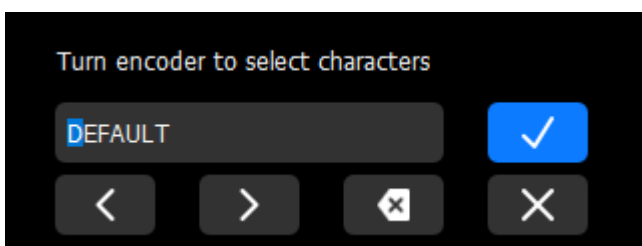

Deleting a configuration

Select **CONFIGURATIONS** > **DELETE** to delete a previously stored configuration.



Loading the default configuration

Select **CONFIGURATIONS > LOAD DEFAULT**.

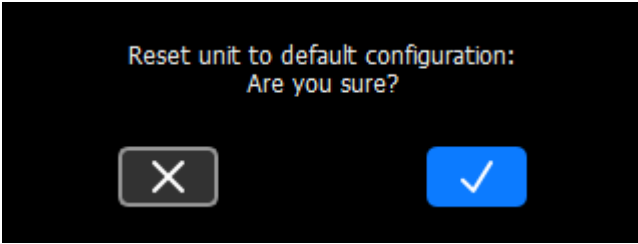

Default configuration

- Mute: all unmuted, except BUS.
- Gain: all with 0 dB gain, except:
 - MON with -12 dB gain
 - GEN with -42 dB gain (pink noise, off)
 - Media Player with -36 dB (off)
- Polarity: all with positive polarity.
- Delay: all at 0 ms, time-alignment off, 8x8 matrix delay off.
- Mic/Line settings: phantom power and HPF off, and analog preamp gain at 0 dB.
- Group parameters: cleared.
- Matrix mixer:

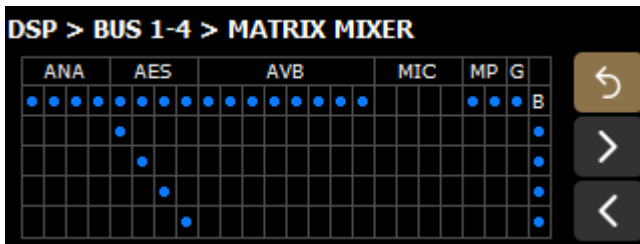

Exporting configurations

Export configurations to a USB drive connected to one of the USB ports.

P1 supports USB drives using the FAT 16 or FAT 32 file system.

- Select **CONFIGURATIONS** > **EXPORT (USB)** > **EXPORT SINGLE CFG** to export a single configuration.



Use **FILE** to modify the file name. Use **DIR** to select an existing folder or create a new one.

Single configuration files are saved as *.lcfg.

- Select **CONFIGURATIONS** > **EXPORT (USB)** > **BACKUP ALL CFG** to export all configurations.

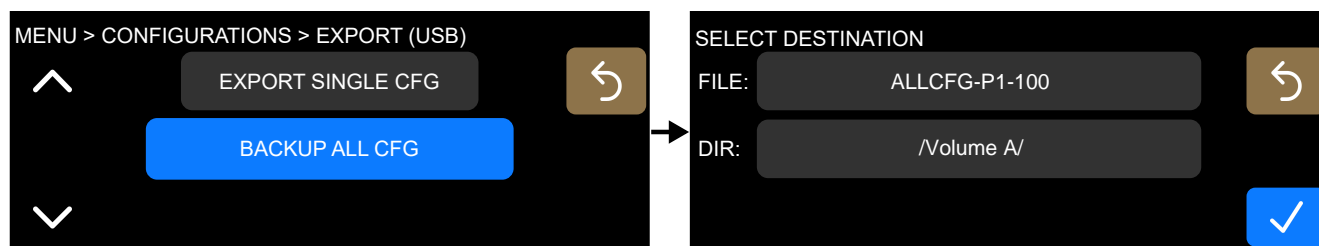

Default file name is **ALLCFG-P1** - followed with the processor IP. Use **FILE** to modify the name. Use **DIR** to select an existing folder or create a new one.

Backup files are saved as *.lbak.

Importing configurations

Import configurations from a USB drive connected to one of the USB ports.

P1 supports USB drives using the FAT 16 or FAT 32 file system.

- Select **CONFIGURATIONS > IMPORT (USB) > IMPORT SINGLE CFG** to import a single configuration.

Select a folder and a *.lcfg file from the USB drive.

Select a memory space for the imported file.

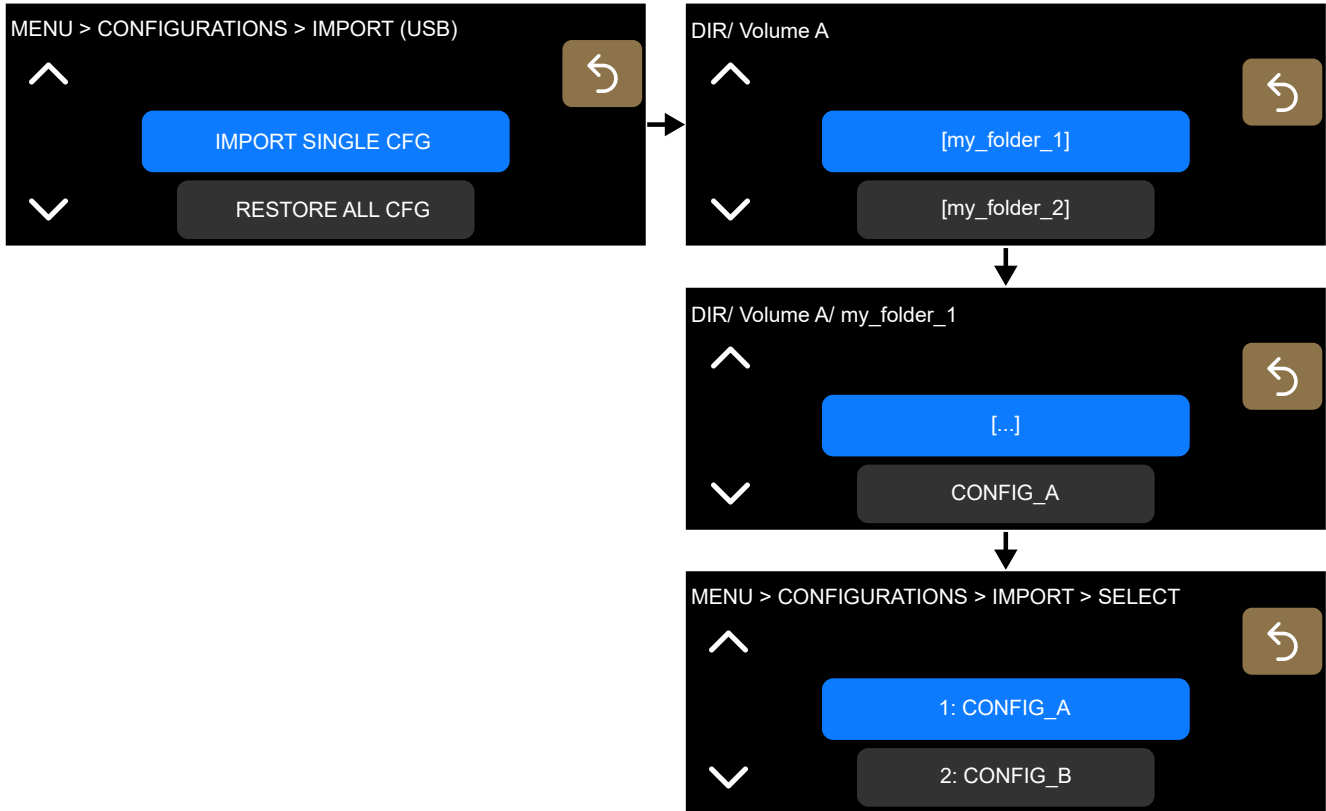

- Select **CONFIGURATIONS > IMPORT (USB) > RESTORE ALL CFG** to import an all-configurations file (30 configurations).

Select a folder and a *.lbak file from the USB drive.

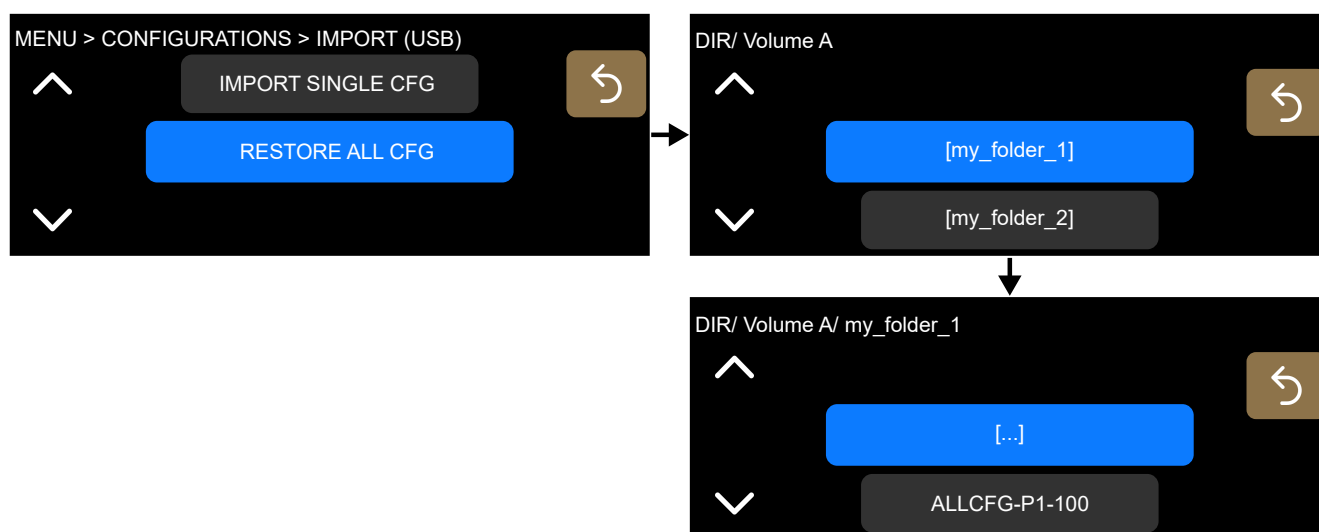

Importing an all-configurations file overwrites the 30 memory spaces.

Media Clock

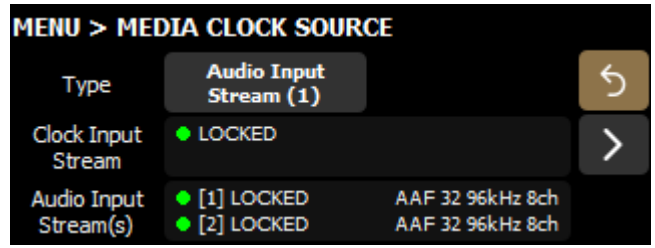
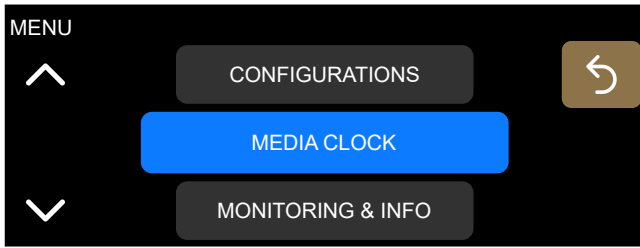

with AVB redundancy mode enabled

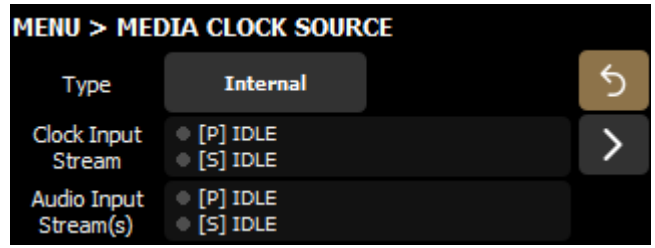
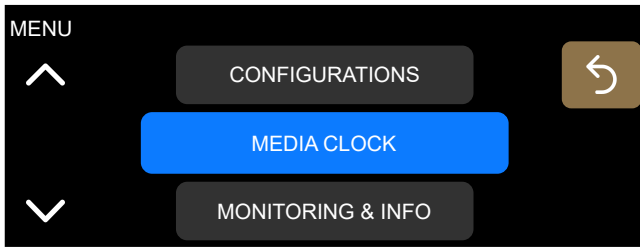

Configuring the media clock source

Media Clock Source displays the status of the AVB audio input streams and clock input stream, and a button to select the media clock source.

Internal

The processor clock runs using its high-precision internal quartz at 96 kHz.

Clock Input Stream

The processor clock runs using the clock of the CRF input stream.

Audio Input Stream(s)

The processor clock runs using the clock of the AVB audio input stream(s).

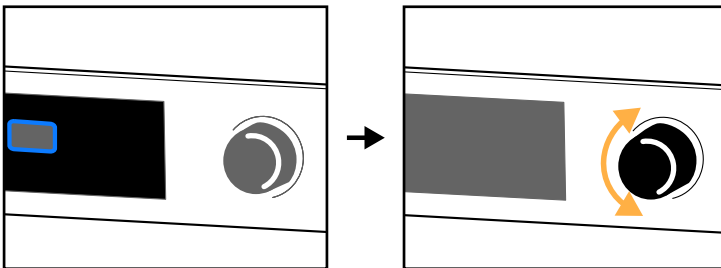

CRF (Clock Reference Format) streams only contain clock information, no media sample, for pre-synchronization (devices are locked before establishing the media streams). Refer to the **Avnu Pro Audio Media Clocking Specification** on avnu.org.

An orange dot indicates a mismatch between the selected media clock source and the media clock used by the audio input streams. There are two ways to resolve it. Either:

- select the audio input stream as the media clock source (typical solution for smaller systems), or
- in large systems, designate one AVB device as the media clock master, connect its media clock stream to the clock input stream using LA Network Manager, and select the clock input stream as the media clock source.

Use the navigation arrow to display the **Clock Output Stream** status and information.

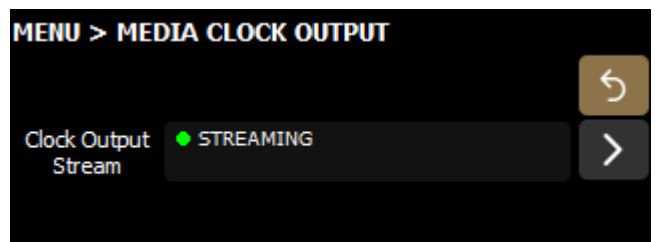
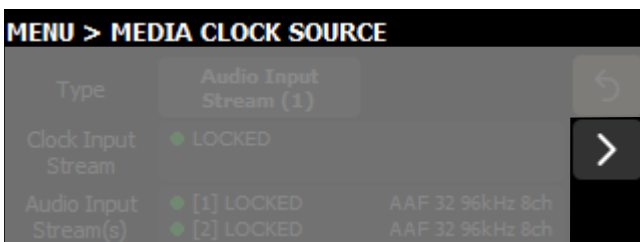

with AVB redundancy mode enabled

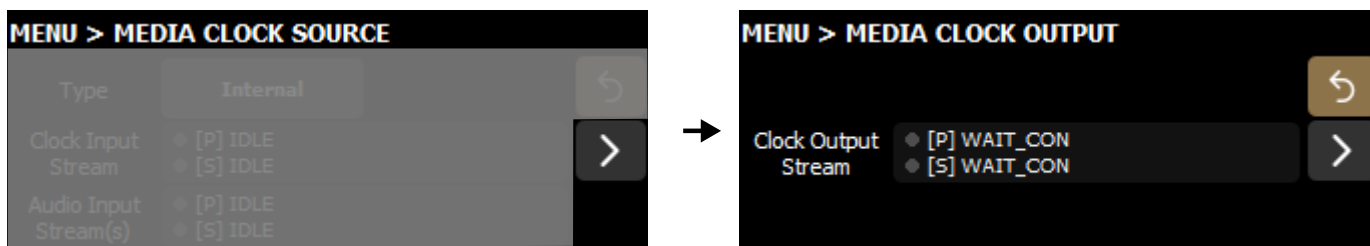

For statuses, refer to [Signal status \(AES and AVB\)](#) (p.37).

8x8 matrix

When two P1 processors are configured to create an 8x8 matrix, it is required that both P1 processors use the same media clock.

To ensure two P1 processors use the same media clock, either:

- Select an identical clock stream for both P1 processors, or
- Set the media clock source of one P1 to **Internal**, and the media clock source of the other P1 to **AVB Audio Input Stream 1**.

Monitoring & Info

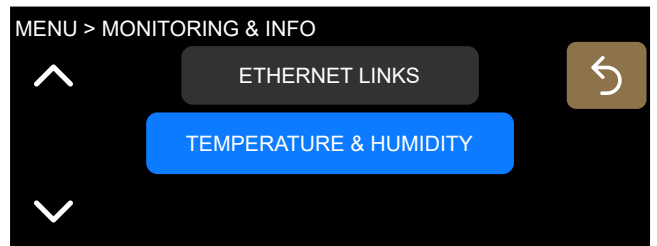
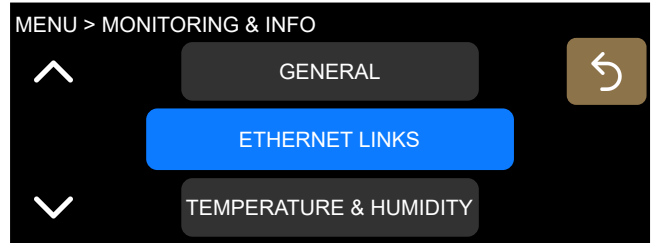
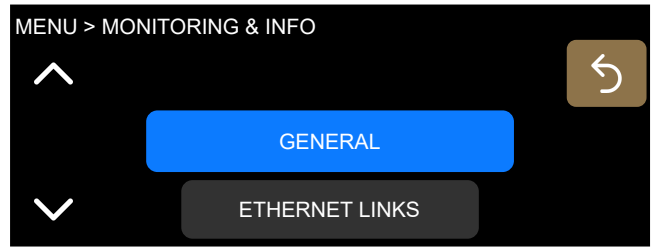
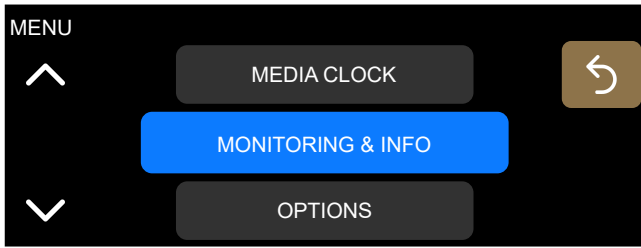

General information

Select **MONITORING & INFO > GENERAL**.

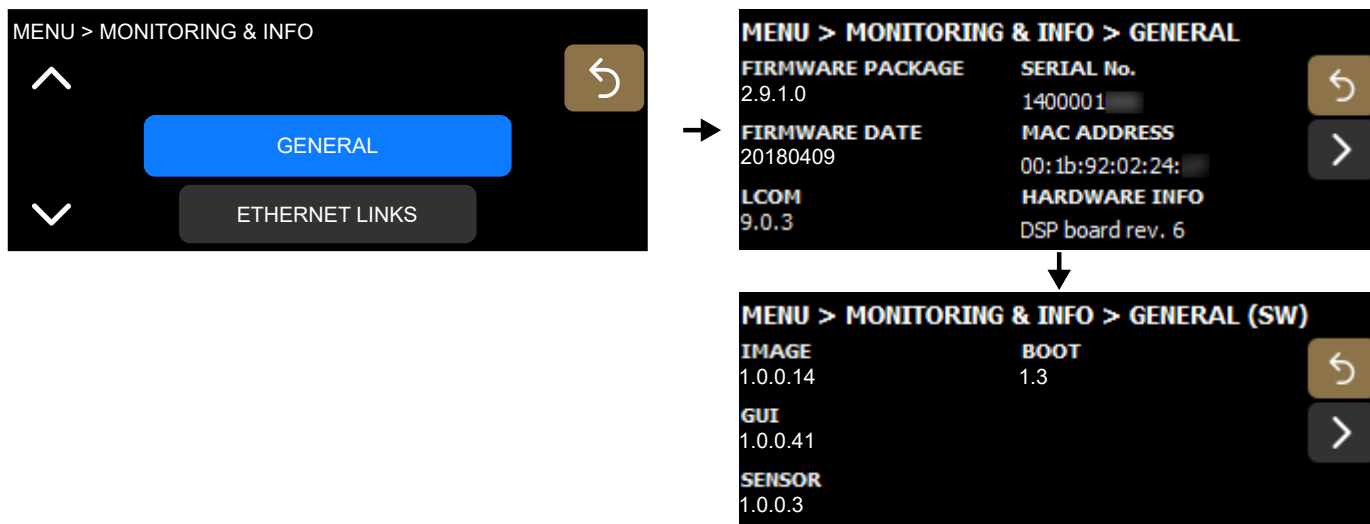

For troubleshooting purposes, it can be useful to communicate this data to your L-Acoustics representative.

Item	Format	Comment
Firmware Package	4 digits separated by periods example: 2.9.1.0	
Firmware Date	YYYYMMDD example: 20180409	
LCOM	3 digits separated by periods example: 9.0.3	L-COM is a proprietary communication protocol based on TCP/IPv4 used by the L-NET Ethernet network.
Serial No.	10-digit number	
MAC Address	6 pairs of hexadecimal digits separated by colons example: 5E:FF:56:A2:AF:15	The MAC address (Media Access Control) is a unique international identification number.
Hardware Info	1-digit number example: DSP board rev. 6	
Software		
Image	4 digits separated by periods example: 1.0.0.14	
GUI (Graphical User Interface)	4 digits separated by periods example: 1.0.0.41	
Sensor	4 digits separated by periods example: 1.0.0.3	
Boot	2 digits separated by periods example: 1.3	

Ethernet Links monitoring

Select **MONITORING & INFO > ETHERNET LINKS**.

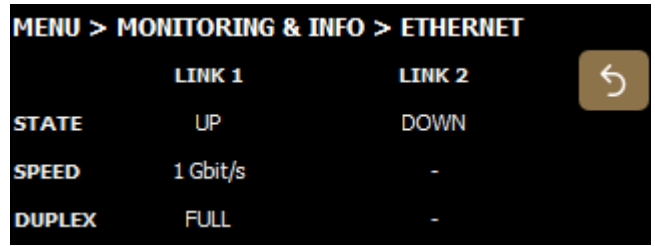
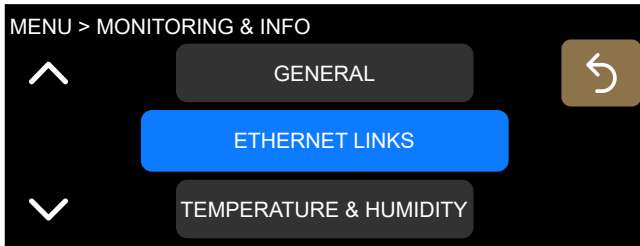

State UP/DOWN

Possible causes of a DOWN state:

- No cable connected to the port.
- Faulty cable connected to the port.
- Cable connected to the port but no device connected at the other end of the cable.
- Port failure.

Speed 10 Mbits/s, 100 Mbits/s, or 1 Gbits/s

Duplex Half/Full

Temperature & Humidity monitoring

Select **MONITORING & INFO > TEMPERATURE & HUMIDITY**.

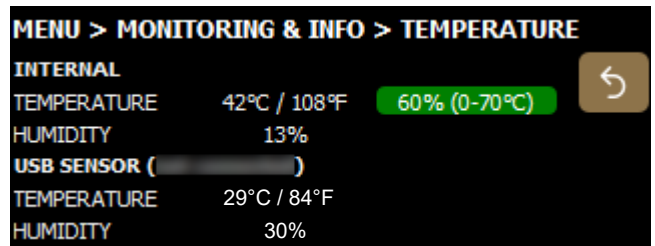
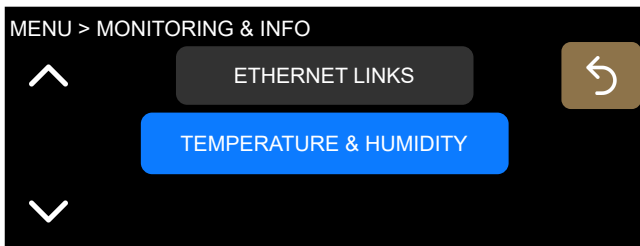

Internal

Temperature and humidity measured from inside the P1 Unit.

A percentage on a color-coded background indicates if P1 is at risk of overheating: green (up to 70%), orange (between 70% and 75%), or red (75% and more).

USB Sensor

Temperature and humidity measured from a connected P1 Sensor.



The P1 Sensor is equipped with a magnet.

Be careful around devices and objects that are sensitive to magnetic fields.

The P1 Sensor can be connected to one of the two P1 USB ports.

Since the P1 internal heat offsets the measurements, it is recommended to use the provided male to female USB extension cable, or a similar cable of up to 15 m / 49 ft in length (4-pin USB Type A).



Refer to the Help of LA Network Manager 3.0 for detailed instructions on system measurements.

Options

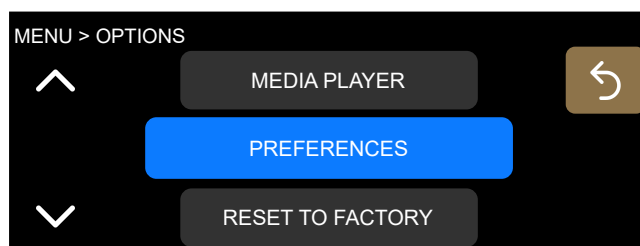
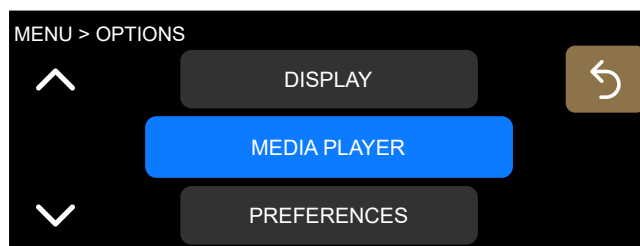
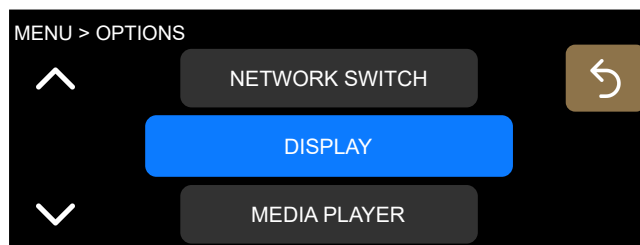
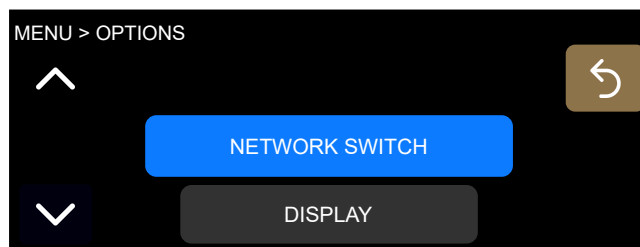
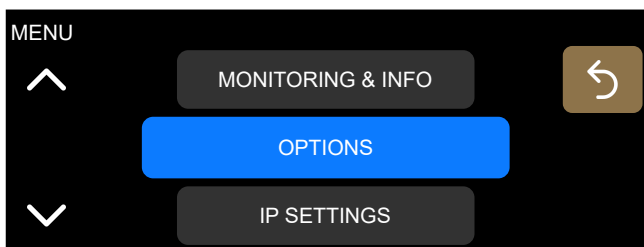

Configuring the network switch

Select **OPTIONS > NETWORK SWITCH**.

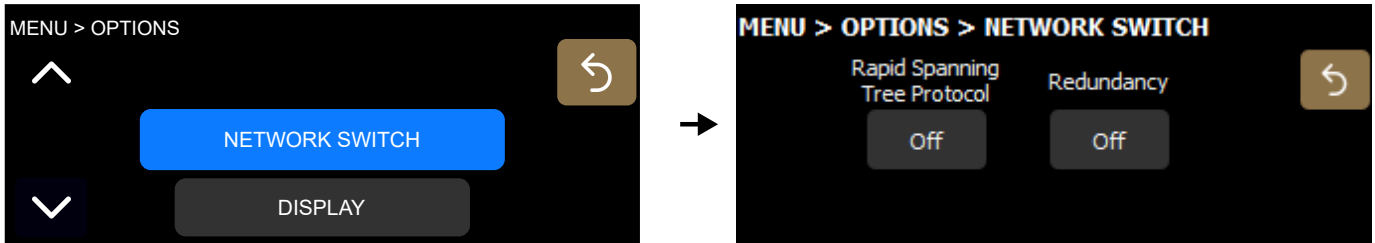

Rapid Spanning Tree Protocol



The Rapid Spanning Tree Protocol (RSTP) is used to detect and automatically disable Ethernet ports to break loops created by redundant links in the network, which avoid broadcast storms that cause network failure.

In case of a cable or switch failure in the network, the protocol re-enables these ports to restore connectivity.

! Always enable Rapid Spanning Tree Protocol when using redundancy mode.

Redundancy

Turn off/on redundancy mode.



When redundancy mode is enabled, P1 no longer operates as an AVB bridge: the two Ethernet ports are independent with their own IP address. P1 can receive and distribute two parallel AVB streams on two separate networks, one primary and one secondary, for seamless backup in case of failure.

i Refer to the **LA Network Manager** Help for detailed instructions (in section **User guide > General**).

Enabling or disabling redundancy mode restarts the device.

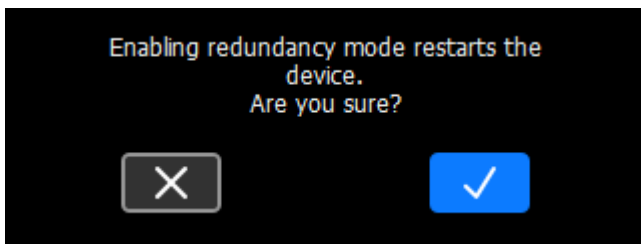

On the main screen, **R** is displayed next to the IP address when redundancy mode is enabled.

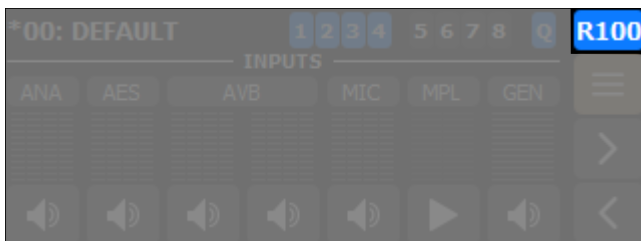

Selecting the display brightness

Select **OPTIONS** > **DISPLAY**.

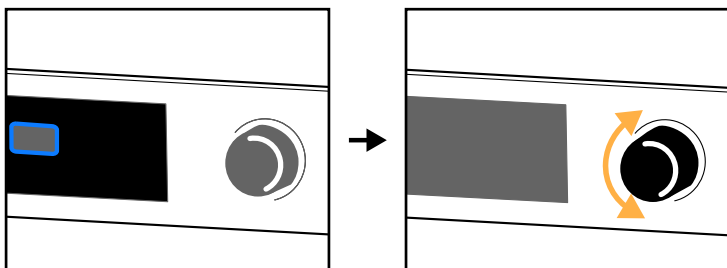
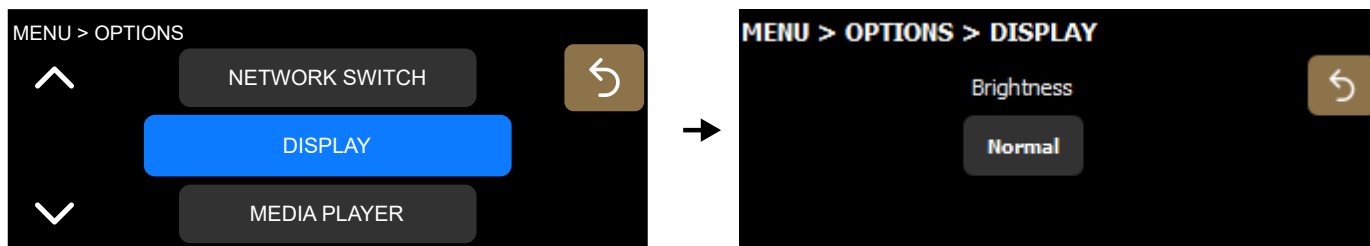

The levels of brightness are: High, Normal, Medium, Low and Off.

Turning off the display is applied after a confirmation. To turn on the display again, use LA Network Manager.

Turning on the Media Player

Select **OPTIONS > MEDIA PLAYER**.

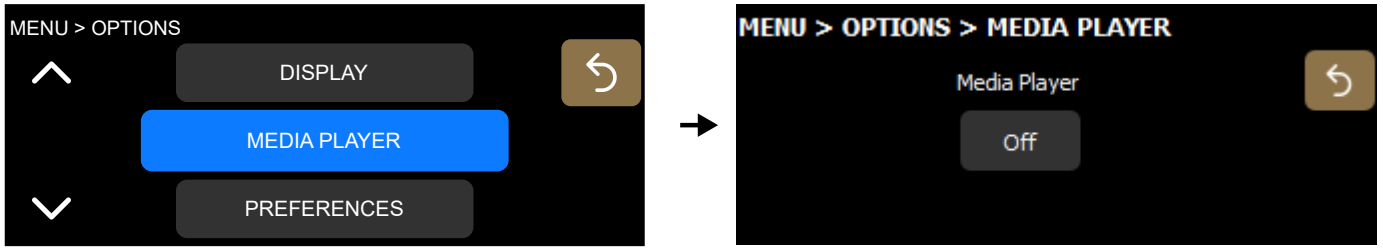

Off / **On** Turn off/on the Media Player option.

i Turning on the Media Player disables AVB inputs 7 and 8.

The disabled inputs appear dimmed on the main screen, and crossed-out in source selection.

Refer to [Media Player \(MPL\)](#) (p.44) for more information on how to use the Media Player.

Selecting preferences

Select **Options > PREFERENCES**.

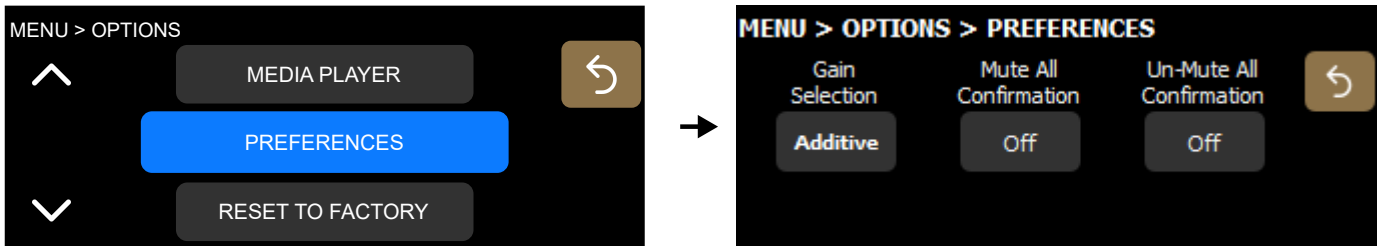

Gain Selection

Additive / **Exclusive** Select whether selections are additive (multiple selections) or exclusive (one item at a time).

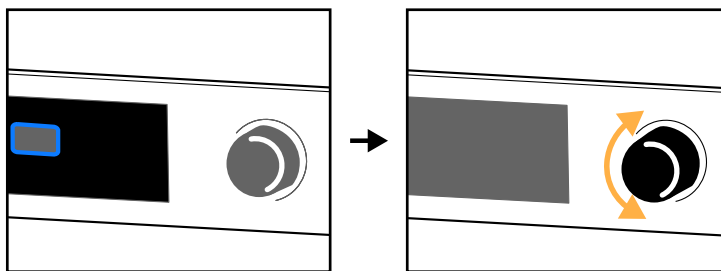

Example with additive selections:

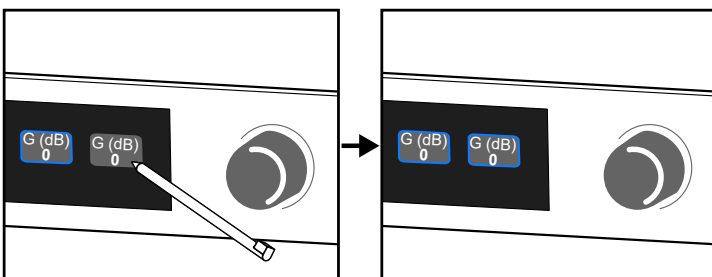

Example with exclusive selections:

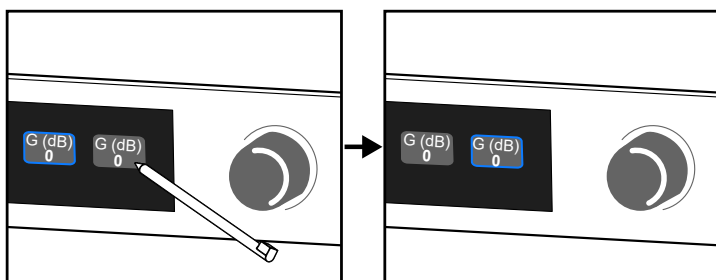

Mute All Confirmation



Select whether a confirmation is required before applying the main screen mute.

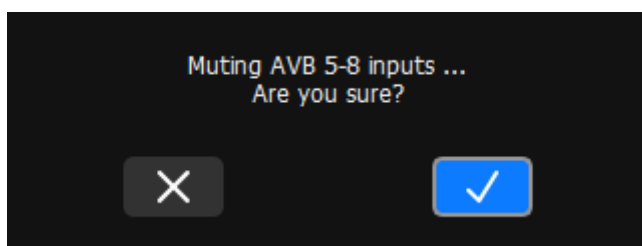

Un-mute All Confirmation



Select whether a confirmation is required before applying the main screen unmute.

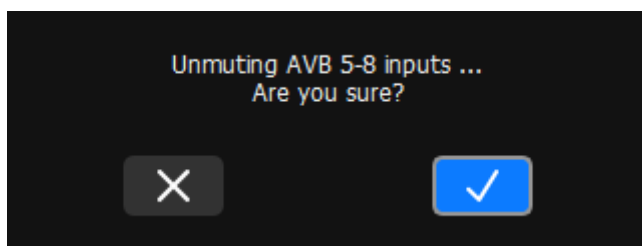

Resetting P1 to factory default

Select **OPTIONS** > **RESET TO FACTORY**.

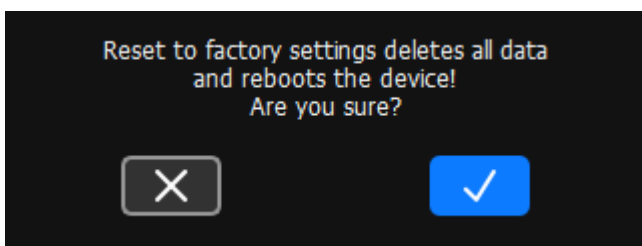

The processor retains its network address.

IP Settings

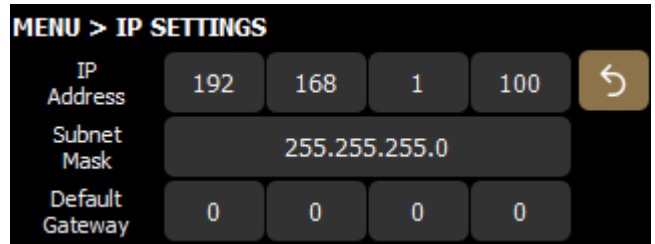
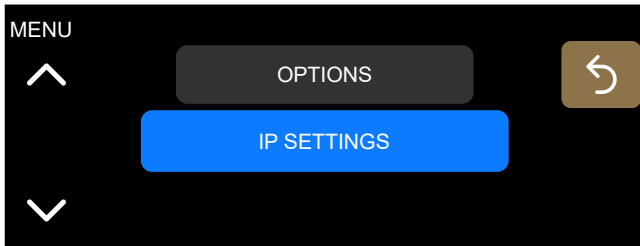

with AVB redundancy mode enabled

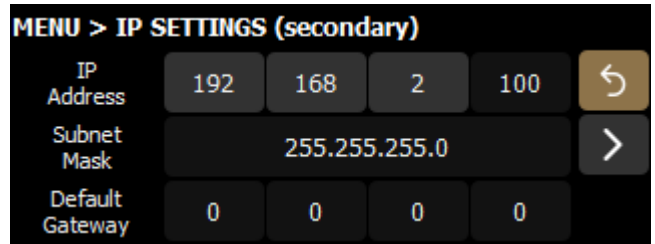
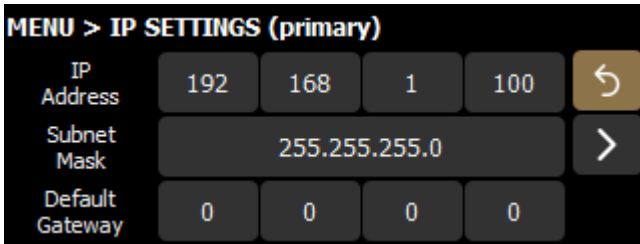

Remote control of processors and amplified controllers requires setting up a private local area Ethernet network to interconnect up to 253 units (and additional devices such as Ethernet switches / AVB bridges) with a single control computer. This Ethernet network, called L-NET, uses L-COM PROTOCOL, a proprietary communication protocol based on TCP/IPv4.

An IP address is a unique identifier for a network device on a given IP network. In IPv4 networking, it is made of 4 bytes (32 bits). An IP address is composed of a subnet address and a host address. The host address serves as a unique device identifier on the subnet. The subnet mask determines how many bits define the subnet address, and how many define the host address.

By convention, the first possible number of the host address is reserved to designate the subnet, and the last number is reserved to communicate with all devices of the subnet (IP broadcast address).

The factory default IP settings of all L-Acoustics devices are:

- IP address: 192.168.1.100
- Subnet address: 192.168.1.0/24
- IP broadcast address: 192.168.1.255
- Subnet mask: 255.255.255.0

With these settings, the first three bytes of the IP address (192.168.1) define the subnet address, and the last byte is the host address (100).

In general, it is recommended to:

- Use the default subnet address and subnet mask.
- Edit the device host address to provide a unique identifier to each unit: use consecutive IP addresses starting from 192.168.1.**1** up to 192.168.1.**253**.
- Set the control computer to 192.168.1.**254**.

However, it is possible to configure other IP settings when required by network administration. Subnet mask may be defined from 255.0.0.0 to 255.255.255.0, and the IP and gateway addresses must both belong to one of the following IP ranges (standards for Private Local Area Networks):

- 10.0.0.1 to 10.255.255.254
- 100.64.0.1 to 100.127.255.254
- 172.16.0.1 to 172.31.255.254
- 169.254.0.1 to 169.254.255.254 (not recommended)
- 192.168.0.1 to 192.168.255.254

! LA Network Manager and its host computer must be using the same subnet and Subnet mask as the units.

In **AVB redundant mode**, the host address is always made identical for both the Primary and the Secondary network. The subnet address of the Secondary Network is that of the Primary +1. For example, with default settings:

- Primary port: 192.168.**1**.100
- Secondary port: 192.168.**2**.100

The subnet mask setting always applies to both networks. When using smaller subnet masks, the host address is also made identical. For example:

- Primary port: 172.**16**.1.100
- Secondary port: 172.**17**.1.100

The Gateway address is only available for the Primary network.

Configuring the IP settings

! LA Network Manager and its host computer must be using the same subnet and Subnet mask as the units.

Make sure that:

- The IP address is included in one of the supported IP ranges.
- The gateway is set to an IP belonging to the same subnet, or is set to 0.0.0.0 if not used.

IP address

Values for the first byte (first number) are restricted to Private Local Area Network prefixes: 10, 100, 169, 172, and 192.

For the first three bytes, set all Units of a system to the same values (for instance 192.168.1) for remote control by LA Network Manager.

Subnet mask

The widest subnet mask that can be used is 255.255.255.0.

Wider subnet masks, such as 255.255.255.128, are not supported.

Gateway

A gateway IP address is an advanced setting reserved for specific applications such as amusement parks, campuses, and multi-room venues with a centralized third-party supervision tool (SNMP, Crestron, Extron, Q-SYS). In such contexts, the supervision tool is often located in a different subnet that is interconnected with the subnets of the units. Interconnection is achieved thanks to a gateway. The gateway address must be set on the units to enable communication with the supervision tool.

! If the first byte of the gateway IP address is set to 0, the three other bytes are reset to 0 upon validation.

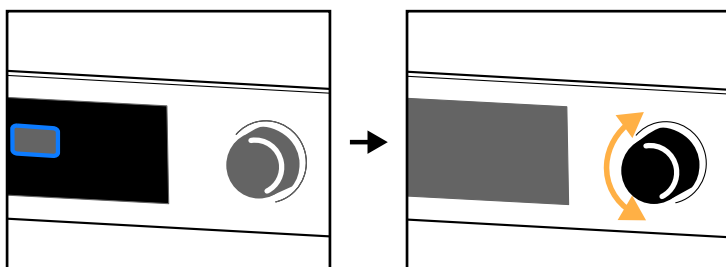

Identifying P1

When P1 is connected to the L-NET network, it is possible to identify it among other processors on the Workspace of LA Network Manager, and conversely in the physical setup.

During identification:

- On the Workspace of LA Network Manager, the identified P1 blinks in yellow.
- On the identified P1, the screen displays **IDENTIFICATION** and the complete IP address on a blinking yellow background.

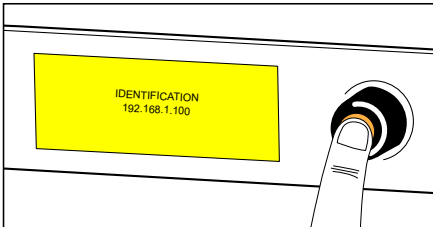

To identify a unit on the Workspace of LA Network Manager, press and hold the encoding wheel.

To identify a unit in the physical setup, refer to the **LA Network Manager Help**.

Corrective maintenance

Introduction

Presentation

This section is intended for end users and gathers the level 1 procedures.

Troubleshooting and diagnosis (p.74)

This section contains the diagnosis tables and procedures to identify the issues and how to address them.

Exploded view (p.78)

This illustration gives an overview of the order in which the elements must be disassembled and reassembled. Each assembly refers to the corresponding D/R procedure and the necessary repair kit(s).

Disassembly and Reassembly procedures (p.79)

This section contains the maintenance procedures for each assembly identified in the exploded view.

Inspection and preventive maintenance (p.16)

These checks allow to detect an issue. The quality control must be performed regularly.

Equipment and tools

Equipment

Before performing preventive maintenance on this product, make sure all the equipments listed are available.

- dry cloth
- computer with LA Network Manager (version 2.6 minimum) and CAT5e U/FTP cable

Troubleshooting and diagnosis

For any issue, consider the diagnosis tables for the possible causes and inspection procedures (if any).

Power issues

The processor does not turn on.

possible cause	diagnosis/procedure
power cord is not connected	<ul style="list-style-type: none"> • check that the power cord is connected to mains • check that the IEC C13 connector is properly connected and locked • check that the on/off switch is on
mains failure or incompatible voltage	check that mains are available and that voltage is compatible (100 V AC - 240 V AC \pm 10%, 50 Hz - 60 Hz)
power cord damaged	inspect the power cord. If necessary, replace it
other causes	contact L-Acoustics

Interface issues

Screen does not display anything (processor responds to remote controls and sound is as expected).

- Contact L-Acoustics.

Screen shows "Please wait..." indefinitely

- Unplug the network cables and power cycle the unit. If the issue does not persist, then there is at least one loop in the Ethernet network: find the loop(s), and remove the cable(s) that create the loop(s), or enable RSTP.
- If the issue persists, contact L-Acoustics.

Both USB ports stopped working (display screen is working)

- Check that the connected devices do not draw more than 500 mA / 5 V. If at least one device does, disconnect it, and power cycle the processor.
- Contact L-Acoustics.

GPIO does not work

- Check that the connected device produces enough power (5 V / 50 mA).
- Check that the connected device does not produce more than 5 V / 50 mA power. If so, contact L-Acoustics.
- Contact L-Acoustics.

Network issues

Impossible to connect a processor to the L-NET network (refer to the LA Network Manager Help for software use).

possible cause	diagnosis/procedure
LA Network Manager is set in offline mode	select the online mode
selected scanning range does not contain the processor IP address	include the processor IP address into the scanning range, or change the processor IP address so that it is included into the scanning range
processor is set with an incorrect IP address, or several devices (processors or amplified controllers) are set with the same IP address	set the computer IP address and subnet mask and the devices IP address as indicated in the LA Network Manager Help
L-NET cable is not plugged or incorrectly plugged	plug and secure CAT5e U/FTP cables into the L-NET connectors on the processor to connect it to other processors, to amplified controllers, to the computer, or to Ethernet switches (each of the processor connectors can be equally used as an IN or LINK connector) Refer to the LA Network Manager Help for network topologies.
L-NET cable is damaged	replace any damaged CAT5e U/FTP cables in the network chain
more than two software clients are already connected to the processor	disconnect all other software clients
firmware failure	restart the processor
other causes	contact L-Acoustics

For the list of AVB reservation errors, refer to [Appendix B - List of AVB reservation \(RSV\) errors](#) (p.86).

Error messages

There are corresponding event messages in LA Network Manager (refer to the **LA Network Manager** Help).

System Message Fan blocked	Displayed if a fan is faulty. The unit remains operational but there is a risk of temperature rising.
System Message Update error	Displayed if the firmware update has failed. Try to restart the unit. If the issue persists, check that each L-NET cable is in working order and is correctly plugged on both ends, and relaunch the update process. If the issue persists, contact L-Acoustics.
System Message Invalid L-NET client	Displayed if the unit detects a connection attempt from a version of LA Network Manager that is not compatible with the unit firmware (typically because the version of LA Network Manager is too old to manage the latest firmware features). Update LA Network Manager to version 2.6 minimum.
System Message Hardware error	Displayed if the firmware encounters a non-specified hardware error during startup or operation.
System Message FPGA error	Displayed if the FPGA cannot be initialized. Try to update the firmware. If the issue persists, contact L-Acoustics.
System Error DSP start-up fault	Displayed if the DSP cannot initialize. Try to update the firmware. If the issue persists, contact L-Acoustics.
System Message DSP error	
Unknown HW revision Contact L-ACOUSTICS	Displayed if the DSP identification cannot be determined.

For the GPIO messages, refer to [General Purpose I/O \(GPIO\)](#) (p.19).

Sound issues

No sound

possible cause	diagnosis/procedure
mains failure	inspect the mains
inputs/outputs are muted	unmute the inputs/outputs
gain value is too low	set an appropriate output gain value If there are fallbacks enabled, set an appropriate input gain value.
incorrect source selection	check the matrix mixer and routing, and input and output AVB mapping If there are fallbacks enabled: select another source that is not reserved for fallback, or unselect the source as a fallback so it is no longer reserved for fallback.
audio source is not plugged, incorrectly plugged, or plugged into the wrong input connector	(re)plug and secure each cable into the audio source and the corresponding input connector on the processor
audio source cable is damaged	replace the cable
incorrect settings on the audio source	set appropriate parameter values on the audio source, in particular the output gain value (refer to the third-party documentation)
non-audible bit stream	check that the AES/EBU source does not deliver non-audio bit stream (encoded audio)
audio source failure	check the presence of input levels, and the current status of the AES/EBU and AVB signals. If no signal reaches the processor, inspect the audio source for failure Reminder: A digital audio source can meet the following failures: no clock, loss of lock, invalid audio (validity bit), CRC error, bipolar encoding error, data slip. An AVB audio source can meet the following failures: switch/talker failure, cable failure, disconnection or "stop streaming" requested by AVB Controller, non-Avnu certified device in network
other causes	contact L-Acoustics

noise, level loss, distorted sound, white noise

possible cause	diagnosis/procedure
AES/EBU audio source is connected to an analog input	check the input signal cabling
gain value too high on the processor	set an appropriate gain value on the processor channels If there are fallback enabled, set an appropriate input gain value.
output gain value too high on the audio source	set an appropriate output gain value on the audio source (refer to the third-party documentation)
input switched to an analog fallback with an incorrect input gain value	set an appropriate input gain value, and inspect the digital audio source for failure Reminder: A digital audio source can meet the following failures: no clock, loss of lock, invalid audio (validity bit), CRC error, bipolar encoding error, data slip. An AVB audio source can meet the following failures: switch/talker failure, cable failure, disconnection or "stop streaming" requested by AVB Controller, non-Avnu certified device in network.
audio source cable incorrectly plugged	unplug/replug the cable on the audio source and the processor
audio source cable damaged	replace the cable
incorrect settings on the audio source	set appropriate parameter values on the audio source (refer to the third-party documentation)
audio source failure	inspect the audio source for failure
other causes	contact L-Acoustics

Exploded view

In the exploded view, each assembly corresponds to a D/R procedure and the necessary repair kit(s).

External modules

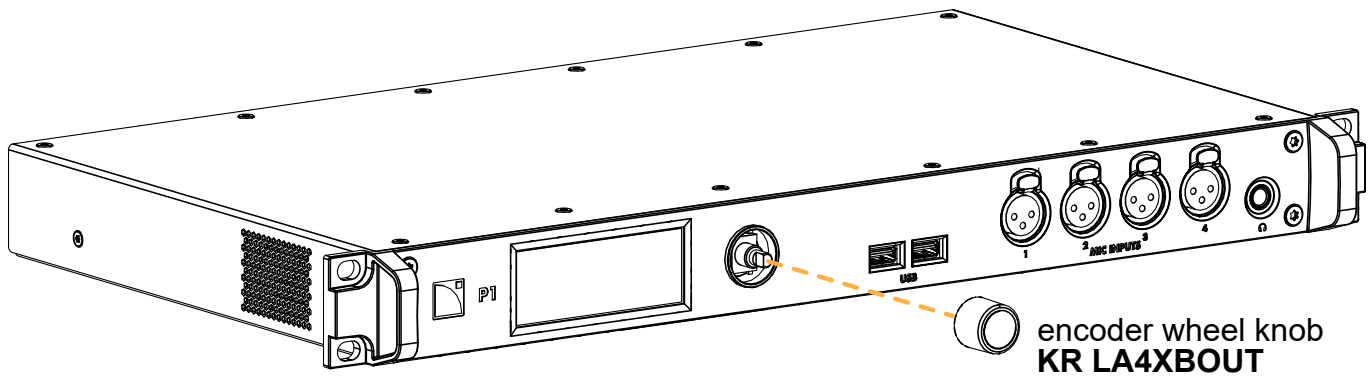

Disassembly and Reassembly procedures

D/R - Encoder wheel knob

Repair kits

KR LA4XBOUT

KR encoding wheel button LA4X/LA12X/P1

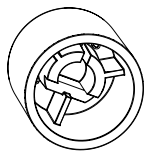

x1

1348

LA4X and LA12X encoder wheel knob



Kit contains additional components that are not required for this procedure.

Exploded view

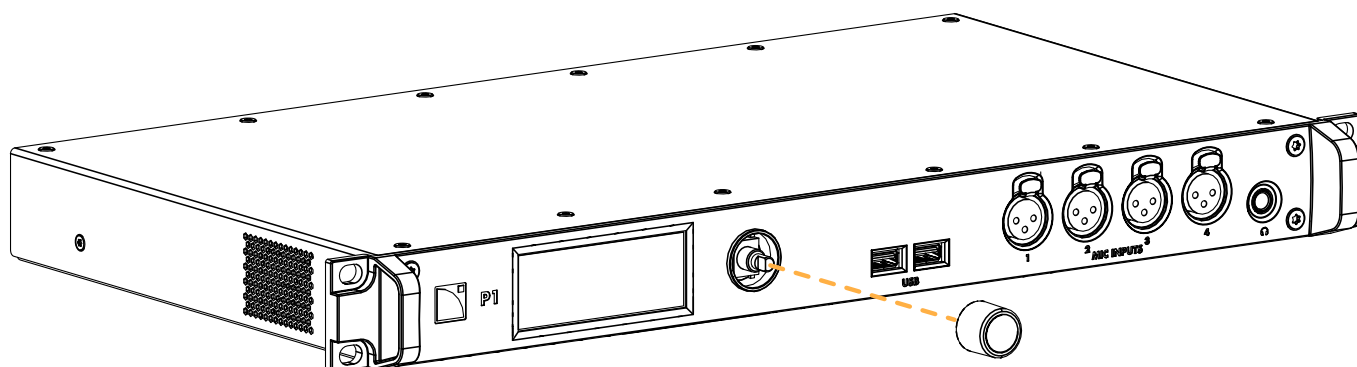

Specifications

All values given in this section are typical values.

General

Mains rating	100 V AC - 240 V AC ($\pm 10\%$), 50 Hz - 60 Hz
Power consumption	Typical: 27 W Idle: 25 W Power supply board rating: 45 W
Digital Signal Processor (DSP)	2 SHARC 32-bit, floating point, 96 kHz sampling rate
Cooling system	fan with temperature-controlled speed (internal temperature probe)
Fan noise (free field, 1 m)	none (fan off) to <38 dBA (at maximum speed)

Storage and operating conditions

Storage temperature	-5 °C / 23 °F to 70 °C / 158 °F
Operating temperature	0 °C / 32 °F to 50 °C / 122 °F
Maximum altitude	5000 m
Climate	moderate and tropical

Interface and connectors

Interface

Display	1 TFT color touchscreen display (320 × 120 px)
Navigation	1 encoding wheel with push button

Front connectors

Mic/Line input	4 female XLR3, balanced mono, ESD protected
USB	2 USB 2.0 host connectors (max. 500 mA / 5 V)
Headphones	1 × 1/4 inch stereo headphone jack

Rear connectors

Analog line input	4 female XLR3, balanced mono, ESD protected
Analog line output	4 male XLR3, balanced mono, ESD protected
Digital input	2 female XLR3, balanced stereo, ESD protected
Digital output	2 male XLR3, balanced stereo, ESD protected
Network	2 × 1 Gb/s Ethernet etherCON® I/O
Mains input	1 IEC C13 V-Lock compatible with on/off switch
General Purpose I/O (GPIO)	1 female DB9 connector

Inputs and outputs

AVB

Featured AVB entities	MILAN™-certified, Avnu™-certified AVB Bridge, Talker and Listener
Standards	Ethernet AVB: IEEE 802.1BA-2011 Transport: IEEE 1722-2016 (AVTP) Control: IEEE 1722.1-2013 (AVDECC)
Input audio stream	Number: 2 independent in normal mode, 2 parallel in redundancy mode Class: A Maximum network latency: 2 ms Formats: AAF PCM32, up to 8 channels, at 48 kHz or 96 kHz IEC 61883-6 AM824, 8 channels, at 48 kHz or 96 kHz
Input clock stream	Number: 1 in normal mode, 2 parallel in redundancy mode Formats: CRF at 48 kHz or 96 kHz
Output audio stream	Number: 2 independent in normal mode, 2 parallel in redundancy mode Class: A Maximum network latency (Talker presentation time offset): fixed at 2 ms Formats: AAF PCM32, up to 8 channels, at 48 kHz or 96 kHz IEC 61883-6 AM824, 8 channels, at 48 kHz or 96 kHz
Output clock stream	Number: 1 in normal mode, 2 parallel in redundancy mode Formats: CRF at 48 kHz or 96 kHz
Media clock	upon user selection: synchronized on clock of the connected AVB input stream (upsampling at 96 kHz in case of stream at 48 kHz) synchronized on clock of the connected CRF stream internal
Streams forwarded by AVB Bridge (in normal mode)	up to 150

Analog line inputs

Number of line inputs	4
Input impedance	22 kΩ balanced
Maximum input level	+22 dBu
Frequency response	±0.1 dB (10 Hz - 20 kHz)
A/D conversion	operating at 32-bit/96 kHz
Input dynamic range	125 dB (-60 dBFS, A-weighted 20 kHz bandwidth)
Distortion THD+N ratio	0.0005%, 1 kHz, 12 dBu (10 dB below max), 20 kHz bandwidth
Channel separation	> 120 dB (20 Hz-20 kHz)
CMRR	53 dB at 1 kHz, 50 Ω balanced source
(IEC 60268-3 3 rd ed 2000-08 method)	

Line outputs

Line output impedance	100 Ω balanced
Maximum output level	+22 dBu
Frequency response	\pm 0.1 dB (10 Hz-20 kHz, load > 600 Ω)
A/D conversion	operating at 32-bit/96 kHz
Output dynamic range	125 dB (-60 dBFS, A-weighted 20 kHz bandwidth)
Distortion THD+N ratio	0.0005%, 1 kHz, 0 dBFS, 20 kHz bandwidth
Channel separation	> 120 dB (at 20 Hz-20 kHz)

Analog mic inputs

Number of mic inputs	4
Input impedance	2.4 k Ω balanced
Maximum input level	+22 dBu at 0 dB gain
A/D conversion	operating at 24 bits/96 kHz
Frequency response	\pm 0.15 dB (20 Hz-20 kHz at 0 dB gain)
Input dynamic range	118 dB (-60 dBFS, A-weighted, 20 kHz bandwidth at 0 dB gain)
Gain range	0 dB to +60 dB by steps of 3 dB
Highpass filter	40 Hz, 12 dB octave (2nd order)
Phantom power	+48 V (10 mA max. per channel)
Distortion THD+N ratio	0.0007%, 1 kHz, 12 dBu (10 dB below max), 20 kHz bandwidth, at 0 dB gain
CMRR (IEC 60268-3 3 rd ed 2000-08 method)	60 dB at 1 kHz, 50 Ω balanced source

Supported digital input format

Standards	AES/EBU (AES3) or electrical S/PDIF (IEC 60958 Type II)
Sampling frequency (Fs)	44.1 kHz, 48 kHz, 88.2 kHz, 96 kHz, 176.4 kHz or 192 kHz
Word length	16 bits, 18 bits, 20 bits or 24 bits

Latency

Input to output (passthrough propagation delay)	0.62 ms (from analog or AES/EBU input to any analog or AES/EBU output)
DSP propagation delay	0.37 ms
Time-aligned redundant audio distribution	AES/EBU and ANALOG: always time-aligned Can be time-aligned to AVB upon user selection for connection to LA4X/LA12X/P1

Sample Rate Converter (SRC)

Sampling frequency	96 kHz
Word length	24 bits
Dynamic range	140 dB
Distortion THD+N	< -120 dBFS (dB Full Scale)
Bandpass ripple	\pm 0.05 dB (20 Hz - 40 kHz, 96 kHz)

Automatic fallback option

Mode	AVB to AES, ANA or MIC AES to ANA or MIC
Switchover conditions	AVB: loss of "locked" status AES: no clock, loss of lock, CRC error, bipolar encoding error or data slip
Constant group delay	AES to ANA or MIC: independent from input Fs AVB to AES, ANA or MIC: upon user selection if source is another P1
Constant level	upon manual user selection of gain, independent from input Fs
Revert to initial input	upon manual user selection

Headphones

Minimum load	32 Ω
Distortion THD+N ratio	0.007%, 1 kHz, -20 dBFS, 20 kHz bandwidth at 32 Ω load 0.004%, 1 kHz, -10 dBFS, 20 kHz A-weighted at 600 Ω load
power	110 mW left + 110 mW right at 32 Ω to 600 Ω load

Signal generator

Signal types	sine wave, sine bursts, 20 Hz-20 kHz sweep, white noise, pink noise
Peak level	from -75 dBFS to 0 dBFS by steps of 0.1 dB

Media player

Supported file formats	*.aif, *.aiff, *.caf, *.flac, *.m4a, *.wav
Supported audio formats	ALAC, FLAC, PCM 44.1 kHz to 192 kHz for mono files 44.1 kHz to 96 kHz for stereo files 16 bits to 32 bits
Stereo output	operating at 24 bits/96 kHz, with automatic high-quality SRC if Fs ≠ 96 kHz

GPIO

Input	1 isolated, floating 1 referenced to chassis ground Lo level: 0 V to 3 V Hi level: 4 V to 24 V (4 mA constant) > 27 V resettable fuse protection 200 V AC galvanic isolation
Output	2 isolated relays: 30 V DC/AC, 1 A contact relay normally open 200 V AC galvanic isolation floating
Power supply	5 V ±5%, 50 mA minimum, referenced to chassis ground, short-circuit protected, ESD protected

Signal processing

Selection	input router and matrix mixer
-----------	-------------------------------

Routing

Sources	4 mic, 4 line, 4 AES/EBU, 8 AVB, 1 signal generator
Routing	8 DSP bus
Outputs	selection from the 20 available inputs, generator, and 8 DSP bus

P1 Sensor

Sensor temperature range	-10 °C / 14 °F to 85 °C / 185 °F
Sensor humidity range	0% to 80% RH (non-condensing)
USB	male USB-A

Remote control

Network connection	dual-port Ethernet Gigabit interface
L-Acoustics remote control software	LA Network Manager from 2.6

Physical data

Height	1U
Weight	3.7 kg / 8.2 lb
Finish	black
Protection rating	IP3x

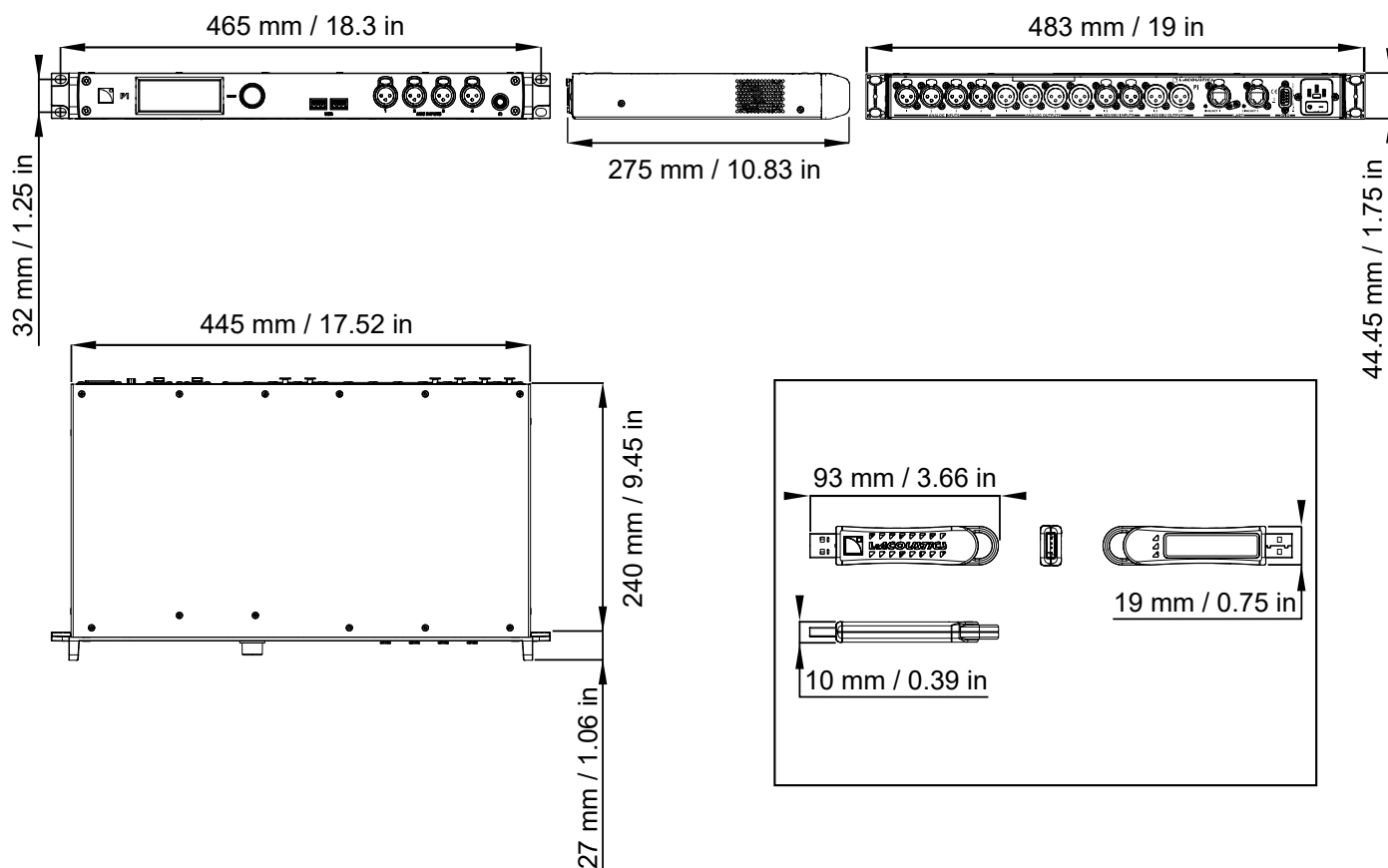

Glossary

CE	Europe
CHK	check procedure
CN	China
D/R	disassembly/reassembly procedure
JP	Japan
KR	repair kit
SMPS	Switched Mode Power Supply (power supply inside of the amplified controller)
US	United States

List of AVB reservation (RSV) errors

code	error	resolution
1	Out of bandwidth	<p>There is not enough bandwidth on the path from the talker to the listener.</p> <ul style="list-style-type: none"> • Check that all the bridges in use have a speed of 1 Gb/s (minimum). • Check the configuration of the bridges: some allow a higher bandwidth allocation for AVB streams (default is 75% of link speed). • Change the stream format: select a lower sampling rate, reduce the number of channels if some are unused. • Optimize the stream and channel usage: for each talker, use the minimum number of streams and the maximum number of channels per stream. • Disconnect some of the already connected streams to release bandwidth.
2	Out of bridge resources	<p>One of the bridges on the path from the talker to the listener reached its limits.</p> <ul style="list-style-type: none"> • Try to reboot the bridges on the path from the talker to the listener. • Try to disconnect some streams.
3	Out of bandwidth for traffic class	See error 1.
4	Stream ID used by another talker	<p>A device on the network is behaving incorrectly.</p> <ul style="list-style-type: none"> • Disconnect and reconnect the stream. • Reboot the talker. • Reboot the bridges on the path from the talker to the listener. • If the talker supports manual configuration of the stream parameters, configure the stream to use another Stream ID.
5	Stream dest. addr. already in use	<p>A device on the network is behaving incorrectly.</p> <ul style="list-style-type: none"> • Disconnect and reconnect the stream. • Reboot the talker. • Reboot the bridges on the path from the talker to the listener.
6	Stream preempted by higher rank	<p>An emergency stream has been connected and reclaimed the bandwidth that was used by the Unit stream.</p> <ul style="list-style-type: none"> • Wait until the emergency stream is disconnected (bandwidth is automatically reallocated). • Try the resolutions of error 1.
7	Reported latency has changed	<p>A device on the network is behaving incorrectly.</p> <ul style="list-style-type: none"> • Disconnect and reconnect the stream. • Reboot the talker. • Reboot the bridges on the path from the talker to the listener.

code error	resolution
8 Egress port is not AVB capable	<p>Temporarily displayed when a network cable is disconnected then reconnected.</p> <p>If displayed for more than a few seconds, it indicates one of the switches in the network is non-AVB capable, or is configured incorrectly.</p> <ul style="list-style-type: none"> • Only use AVB-capable bridges on the path from the talker to the listener. • If the bridges support configuration of the SR Class priority, configure all the bridges with the same setting (default is 3 for Class A streams).
9 Use a different dest. address	<p>One of the bridges on the path from the talker to the listener has used all of its internal resources.</p> <ul style="list-style-type: none"> • If the talker supports manual configuration of the stream parameters, configure it to use another destination MAC address. • Try to reboot the talker to make it use another MAC address. • Disconnect some already reserved streams.
10 Out of MSRP resources	<p>One of the bridges on the path from the talker to the listener has reached its limits.</p> <ul style="list-style-type: none"> • Try to disconnect some streams. • Try to reboot the bridges on the path from the talker to the listener.
11 Out of MMRP resources	<p>One of the bridges on the path from the talker to the listener has reached its limits.</p> <ul style="list-style-type: none"> • Try to disconnect some streams. • Try to reboot the bridges on the path from the talker to the listener.
12 Cannot store dest. addr.	<p>One of the bridges on the path from the talker to the listener has reached its limits.</p> <ul style="list-style-type: none"> • Try to disconnect some streams. • Try to reboot the bridges on the path from the talker to the listener.
13 Req. priority is not an SR class	<p>The talker is behaving incorrectly, or the switches configuration has changed while the stream was active.</p> <ul style="list-style-type: none"> • Disconnect and reconnect the stream. • Reboot the talker.
14 Max frame size too big for media	<p>The talker is behaving incorrectly.</p> <ul style="list-style-type: none"> • Disconnect and reconnect the stream. • Reboot the talker.
15 MSRP fan-in ports limit reached	<p>One of the bridges on the path from the talker to the listener has AVB ports usage limitation and has reached its limits.</p> <ul style="list-style-type: none"> • If possible, change the configuration of the bridges to allow more simultaneous usage of AVB ports. • Review the network cabling to use less ports on the limiting bridge(s).
16 Changed first value for reg. stream ID	<p>A device on the network is behaving incorrectly.</p> <ul style="list-style-type: none"> • Disconnect and reconnect the stream. • Reboot the talker. • Reboot the bridges on the path from the talker to the listener.
17 VLAN blocked on egress port	<p>One of the bridges on the path from the talker to the listener is incorrectly configured.</p> <ul style="list-style-type: none"> • Configure the bridges to allow dynamic VLAN registration. • If possible, configure the talker to use a different VLAN (one that is authorized by the bridges).
18 VLAN tagging off on egress port	<p>One of the bridges on the path from the talker to the listener is incorrectly configured.</p> <ul style="list-style-type: none"> • Configure the bridges to enable VLAN tagging of the egress packets.

code error	resolution
19 SR class priority mismatch	A wrongly configured AVB bridge is present in the network. <ul style="list-style-type: none"> Configure all the bridges with the same setting (default is 3 for Class A streams).

List of AVB connection (CON) errors

code error	resolution
2 Talker unknown ID	The AVB controller has requested the listener to connect to a talker, specified by an identifier, but that identifier does not exist, or no longer exists. Check that the AVB controller is sending the correct information.
3 Talker dest. mac fail	A listener is trying to connect to a talker while the talker is allocating the destination MAC for the stream. If displayed for more than a few seconds, check for non-Avnu certified devices on the network. Preferably use Avnu-certified devices.
4 Talker no stream index	A third-party talker has an issue allocating an ID to a stream. Refer to the third-party documentation.
5 Talker no bandwidth	The talker cannot deliver all of its streams because a switch on the network does not have enough bandwidth. Use switches with enough bandwidth capabilities.
6 Talker exclusive	A third-party talker that supports a limited number of listeners has reached its limits. Refer to the third-party documentation.
13 Talker misbehaving	The talker has an internal error. Reboot the talker.
16 Controller not authorized	Another AVB controller has locked the talker. Unlock the talker.
17 Incompatible request	The listener is trying to connect to a talker that is already streaming with a different traffic class, or does not support the requested traffic class. If in redundant mode, check the cabling (port 1 must be used for the Primary network and port 2 for the Secondary network).
31 Not supported	Request is unknown to a third-party, non-MILAN compatible talker. Refer to the third-party documentation.

Licenses and copyrights

The processor firmware includes software packages released under open source licenses.

To access the list of the packages and their licenses, open a web browser and type the full IP address of a connected processor in the address bar.

Approvals

EU Declaration of Conformity (DoC)

EU Declaration of Conformity (DoC)

We

L-Acoustics
 13 rue Levacher Cintrat
 Parc de la Fontaine de Jouvence
 91462 Marcoussis Cedex
 France
 +33 (0)1 69 63 69 63
 info@l-acoustics.com

declare that the DoC is issued under our sole responsibility and belongs to the following product:

P1 processor

The object of the declaration described above is in conformity with the relevant Union harmonization legislation:

2014/30/EU: Electro-Magnetic Compatibility Directive

2014/35/EU: Low Voltage Directive

2011/65/EU: RoHS 2 Directive

The following harmonized standards and technical specifications have been applied:

EN 62368-1: 2014 Audio/video, information and communication technology equipment — Part 1: Safety requirements

EN 55032: 2015 Electromagnetic compatibility of multimedia equipment — Emission Requirements

EN 55035:2017 Electromagnetic compatibility of multimedia equipment — Immunity requirements

EN 50581: 2012 Technical documentation for the assessment of electrical and electronic products with respect to the restriction of hazardous substances

Technical file compiled by:

Genio KRONAUER
 13 rue Levacher Cintrat
 Parc de la Fontaine de Jouvence
 91462 Marcoussis Cedex
 France

Year CE marking was first affixed: 2018

Issued in Marcoussis, France

04/05/2018



Genio KRONAUER, Electronics Director

P1 is certified with the following:



P1 is compliant with the following:



Avnu Alliance and the Avnu design mark are registered trademarks and/or service marks of Avnu Alliance.



L-Acoustics

13 rue Levacher Cintrat - 91460 Marcoussis - France
+33 1 69 63 69 63 - info@l-acoustics.com
www.l-acoustics.com

 **L.ACOUSTICS**
GROUP